

Panasonic®

Model No.

TH-42LF20E
TH-47LF20E

Operating Instructions

FULL HD LCD Display



HDMI

English

Please read these instructions before operating your set and retain them for future reference.

Dear Panasonic Customer

Welcome to the Panasonic family of customers. We hope that you will have many years of enjoyment from your new LCD Display.

To obtain maximum benefit from your set, please read these Instructions before making any adjustments, and retain them for future reference.

Retain your purchase receipt also, and note down the model number and serial number of your set in the space provided on the rear cover of these instructions.

Visit our Panasonic Web Site <http://panasonic.net>

Table of Contents

Important Safety Notice	3	Screensaver (For preventing image retention)	29
Safety Precautions	4	Setup of Screensaver Time	30
Accessories	7	Wobbling	30
Accessories Supply	7	Reduces power consumption	31
Remote Control Batteries	7	Customizing the Input labels	32
Connections	8	Selecting the On-Screen Menu Language	33
AC cord connection and fixing, cable fixing.....	8	Customizing the On-Screen Menu Display	33
Video equipment connection	8	Setup for MULTI DISPLAY	34
VIDEO and COMPONENT / RGB IN connection	9	How to Setup MULTI DISPLAY	34
HDMI connection.....	10	Setup for Input Signals	36
DVI-D IN connection.....	10	Component / RGB-in select.....	36
PC Input Terminals connection.....	11	Signal menu	37
SERIAL Terminals connection	12	3D Y/C Filter.....	37
Power On / Off	13	Colour system	38
Selecting the input signal	15	Cinema reality	38
Basic Controls	16	XGA Mode	38
ASPECT Controls	18	Noise reduction	39
Digital Zoom	19	Sync	39
On-Screen Menu Displays	20	Input signal display	40
Adjusting Pos. /Size	22	Options Adjustments	41
Picture Adjustments	24	Troubleshooting	43
Advanced settings	25	Applicable Input Signals	44
Sound Adjustment	26	Shipping condition	45
PRESENT TIME Setup / Set up TIMER	27	Specifications	46
PRESENT TIME Setup.....	27		
Set up TIMER.....	28		

Trademark Credits

- VGA is a trademark of International Business Machines Corporation.
- Macintosh is a registered trademark of Apple Inc., USA.
- SVGA, XGA, SXGA and UXGA are registered trademarks of the Video Electronics Standard Association. Even if no special notation has been made of company or product trademarks, these trademarks have been fully respected.
- HDMI, the HDMI Logo, and High-Definition Multimedia Interface are trademarks or registered trademarks of HDMI Licensing LLC in the United States and other countries.

Note:

Image retention may occur. If you display a still picture for an extended period, the image might remain on the screen. However, it will disappear after a while.

Important Safety Notice

WARNING

- 1) To prevent damage which may result in fire or shock hazard, do not expose this appliance to dripping or splashing.
Do not place containers with water (flower vase, cups, cosmetics, etc.) above the set. (including on shelves above, etc.)
No naked flame sources, such as lighted candles, should be placed on / above the set.
- 2) To prevent electric shock, do not remove cover. No user serviceable parts inside. Refer servicing to qualified service personnel.
- 3) Do not remove the earthing pin on the power plug. This apparatus is equipped with a three pin earthing-type power plug. This plug will only fit an earthing-type power outlet. This is a safety feature. If you are unable to insert the plug into the outlet, contact an electrician.
Do not defeat the purpose of the earthing plug.
- 4) To prevent electric shock, ensure the earthing pin on the AC cord power plug is securely connected.

CAUTION

This appliance is intended for use in environments which are relatively free of electromagnetic fields. Using this appliance near sources of strong electromagnetic fields or where electrical noise may overlap with the input signals could cause the picture and sound to wobble or cause interference such as noise to appear. To avoid the possibility of harm to this appliance, keep it away from sources of strong electromagnetic fields.

IMPORTANT: THE MOULDED PLUG

FOR YOUR SAFETY, PLEASE READ THE FOLLOWING TEXT CAREFULLY.

This display is supplied with a moulded three pin mains plug for your safety and convenience. A 10 amp fuse is fitted in this plug. Shall the fuse need to be replaced, please ensure that the replacement fuse has a rating of 10 amps and that it is approved by ASTA or BSI to BS1362.

Check for the ASTA mark  or the BSI mark  on the body of the fuse.

If the plug contains a removable fuse cover, you must ensure that it is refitted when the fuse is replaced.

If you lose the fuse cover the plug must not be used until a replacement cover is obtained.

A replacement fuse cover can be purchased from your local Panasonic dealer.

Do not cut off the mains plug.

Do not use any other type of mains lead except the one supplied with this display.

The supplied mains lead and moulded plug are designed to be used with this display to avoid interference and for your safety.

If the socket outlet in your home is not suitable, get it changed by a qualified electrician.

If the plug or mains lead becomes damaged, purchase a replacement from an authorized dealer.

WARNING : — THIS DISPLAY MUST BE EARTHED.

How to replace the fuse. Open the fuse compartment with a screwdriver and replace the fuse.

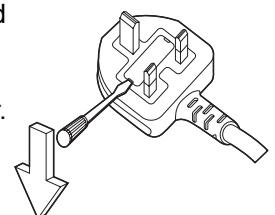

Safety Precautions

WARNING

■ Setup

This LCD Display is for use only with the following optional accessories. Use with any other type of optional accessories may cause instability which could result in the possibility of injury.

(All of the following accessories are manufactured by Panasonic Corporation.)

- Pedestal TY-STLF20

Always be sure to ask a qualified technician to carry out set-up.

Small parts can present choking hazard if accidentally swallowed. Keep small parts away from young children. Discard unneeded small parts and other objects, including packaging materials and plastic bags/sheets to prevent them from being played with by young children, creating the potential risk of suffocation.

Do not place the Display on sloped or unstable surfaces.

- The Display may fall off or tip over.

Do not place any objects on top of the Display.

- If water is spilled onto the Display or foreign objects get inside it, a short-circuit may occur which could result in fire or electric shock. If any foreign objects get inside the Display, please consult your local Panasonic dealer.

Transport only in upright position!

- Transporting the unit with its display panel facing upright or downward may cause damage to the internal circuitry.

Ventilation should not be impeded by covering the ventilation openings with items such as newspapers, table cloths and curtains.

For sufficient ventilation;

Leave a space of 10 cm or more at the top, left and right, and 5 cm or more at the rear, and also keep the space between the bottom of the display and the floor surface.

Cautions for Wall Installation

- Wall installation should be performed by an installation professional. Installing the Display incorrectly may lead to an accident that results in death or serious injury. Furthermore, when installing on a wall, a wall hanging bracket that conforms to VESA standards (VESA 400 × 400) must be used.
- When installing the Display vertically, be sure to install the power switch onto the bottom of the Display.

■ When using the LCD Display

The Display is designed to operate on 220 - 240 V AC, 50/60 Hz.

Do not cover the ventilation holes.

- Doing so may cause the Display to overheat, which can cause fire or damage to the Display.

Do not stick any foreign objects into the Display.

- Do not insert any metal or flammable objects into the ventilations holes or drop them onto the Display, as doing so can cause fire or electric shock.

Do not remove the cover or modify it in any way.

- High voltages which can cause severe electric shocks are present inside the Display. For any inspection, adjustment and repair work, please contact your local Panasonic dealer.

Ensure that the mains plug is easily accessible.

An apparatus with CLASS I construction shall be connected to a mains socket outlet with a protective earthing connection.

Do not use any power supply cord other than that provided with this unit.

- Doing so may cause fire or electric shocks.

Securely insert the power supply plug as far as it will go.

- If the plug is not fully inserted, heat may be generated which could cause fire. If the plug is damaged or the wall socket is loose, they shall not be used.

Do not handle the power supply plug with wet hands.

- Doing so may cause electric shocks.

Do not do anything that may damage the power cable. When disconnecting the power cable, pull on the plug body, not the cable.

- Do not damage the cable, make any modifications to it, place heavy objects on top of it, heat it, place it near any hot objects, twist it, bend it excessively or pull it. To do so may cause fire and electric shock. If the power cable is damaged, have it repaired at your local Panasonic dealer.

If the Display is not going to be used for any prolonged length of time, unplug the power supply plug from the wall outlet.

To prevent the spread of fire, keep candles or other open flames away from this product at all times.



■ If problems occur during use

If a problem occurs (such as no picture or no sound), or if smoke or an abnormal odour starts to come out from the Display, immediately unplug the power supply plug from the wall outlet.

- If you continue to use the Display in this condition, fire or electric shock could result. After checking that the smoke has stopped, contact your local Panasonic dealer so that the necessary repairs can be made. Repairing the Display yourself is extremely dangerous, and shall never be done.

If water or foreign objects get inside the Display, if the Display is dropped, or if the cabinet becomes damages, disconnect the power supply plug immediately.

- A short circuit may occur, which could cause fire. Contact your local Panasonic dealer for any repairs that need to be made.

Safety Precautions

CAUTION

■ When using the LCD Display

Do not bring your hands, face or objects close to the ventilation holes of the Display.

- Heated air comes out from the ventilation holes at the top of Display will be hot. Do not bring your hands or face, or objects which cannot withstand heat, close to this port, otherwise burns or deformation could result.

Be sure to disconnect all cables before moving the Display.

- If the Display is moved while some of the cables are still connected, the cables may become damaged, and fire or electric shock could result.

Disconnect the power supply plug from the wall socket as a safety precaution before carrying out any cleaning.

- Electric shocks can result if this is not done.

Clean the power cable regularly to prevent it becoming dusty.

- If dust built up on the power cord plug, the resultant humidity can damage the insulation, which could result in fire. Pull the power cord plug out from the wall outlet and wipe the mains lead with a dry cloth.

Do not burn or breakup batteries.

- Batteries must not be exposed to excessive heat such as sunshine, fire or the like.

Cleaning and maintenance

The front of the display panel has been specially treated. Wipe the panel surface gently using only a cleaning cloth or a soft, lint-free cloth.

- If the surface is particularly dirty, wipe with a soft, lint-free cloth which has been soaked in pure water or water in which neutral detergent has been diluted 100 times, and then wipe it evenly with a dry cloth of the same type until the surface is dry.
- Do not scratch or hit the surface of the panel with fingernails or other hard objects, otherwise the surface may become damaged. Furthermore, avoid contact with volatile substances such as insect sprays, solvents and thinner, otherwise the quality of the surface may be adversely affected.

If the cabinet becomes dirty, wipe it with a soft, dry cloth.

- If the cabinet is particularly dirty, soak the cloth in water to which a small amount of neutral detergent has been added and then wring the cloth dry. Use this cloth to wipe the cabinet, and then wipe it dry with a dry cloth.
- Do not allow any detergent to come into direct contact with the surface of the Display. If water droplets get inside the unit, operating problems may result.
- Avoid contact with volatile substances such as insect sprays, solvents and thinner, otherwise the quality of the cabinet surface may be adversely affected or the coating may peel off. Furthermore, do not leave it for long periods in contact with articles made from rubber or PVC.

Accessories

Accessories Supply

Check that you have the accessories and items shown



Operating Instruction book

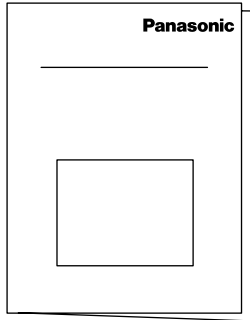

CD-ROM
(Operating instructions)

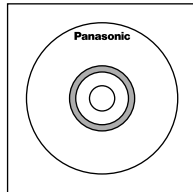

Remote Control
Transmitter
N2QAYB000535

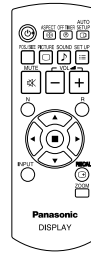

Batteries for the Remote
Control Transmitter
(R6 (UM3) Size × 2)

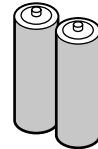

Power supply cord

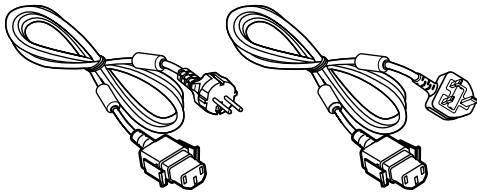

Remote Control Batteries

Requires two R6 batteries.

1. Pull and hold the hook, then open the battery cover.
2. Insert batteries - note correct polarity (+ and -).
3. Replace the cover.

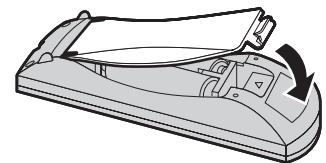
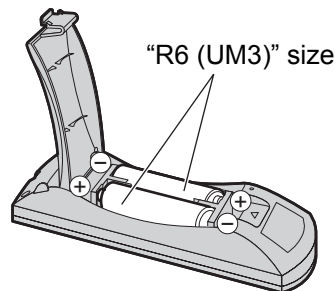
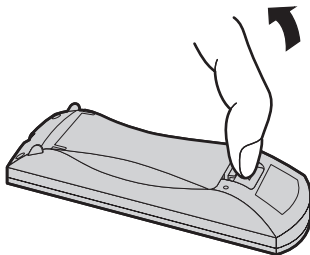

Helpful Hint:

For frequent remote control users, replace old batteries with Alkaline batteries for longer life.

⚠ Precaution on battery use

Incorrect installation can cause battery leakage and corrosion that will damage the remote control transmitter. Disposal of batteries should be in an environment-friendly manner.

Observe the following precaution:

1. Batteries shall always be replaced as a pair. Always use new batteries when replacing the old set.
2. Do not combine a used battery with a new one.
3. Do not mix battery types (example: "Zinc Carbon" with "Alkaline").
4. Do not attempt to charge, short-circuit, disassemble, heat or burn used batteries.
5. Battery replacement is necessary when remote control acts sporadically or stops operating the Display set.
6. Do not burn or breakup batteries.
Batteries must not be exposed to excessive heat such as sunshine, fire or the like.

Connections

AC cord connection and fixing, cable fixing

AC cord fixing

Plug the AC cord into the display unit.
Plug the AC cord until it clicks.
Note:
Make sure that the AC cord is locked on both the left and right sides.

Unplug the AC cord

Unplug the AC cord pressing the two knobs.
Note:
When disconnecting the AC cord, be absolutely sure to disconnect the AC cord plug at the socket outlet first.

Cable fixing

Fix the cable in place using the bead band attached to the display.

1 Remove the bead band

Bead band

2 Bundle the cables

① Remove ④ Stopper
② ③ Bundle the cables

3 Attach the bead band

① Pass through to the back
②

Video equipment connection

AV IN
HDMI1, HDMI2
HDMI Input Terminal
(see page 10)

DVI-D IN
DVI-D Input Terminal
(see page 10)

COMPONENT/RGB IN
Component/RGB Video
Input Terminal
(see page 9)

SERIAL
Control the Display by
connecting to PC
(see page 12)

AV IN
VIDEO
Composite Video Input Terminal
S-VIDEO
S-VIDEO Input Terminal
(see page 9)

PC IN
PC Input Terminal
(see page 11).

VIDEO and COMPONENT / RGB IN connection

Note:

Additional equipment, cables and adapter plugs shown are not supplied with this set.

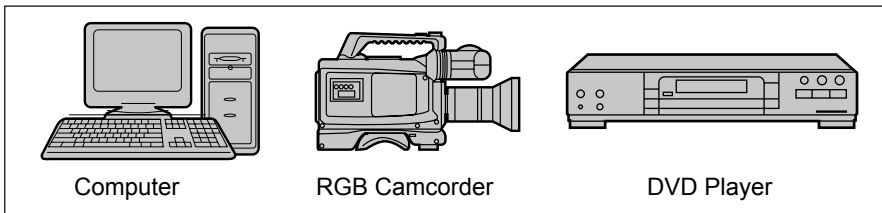
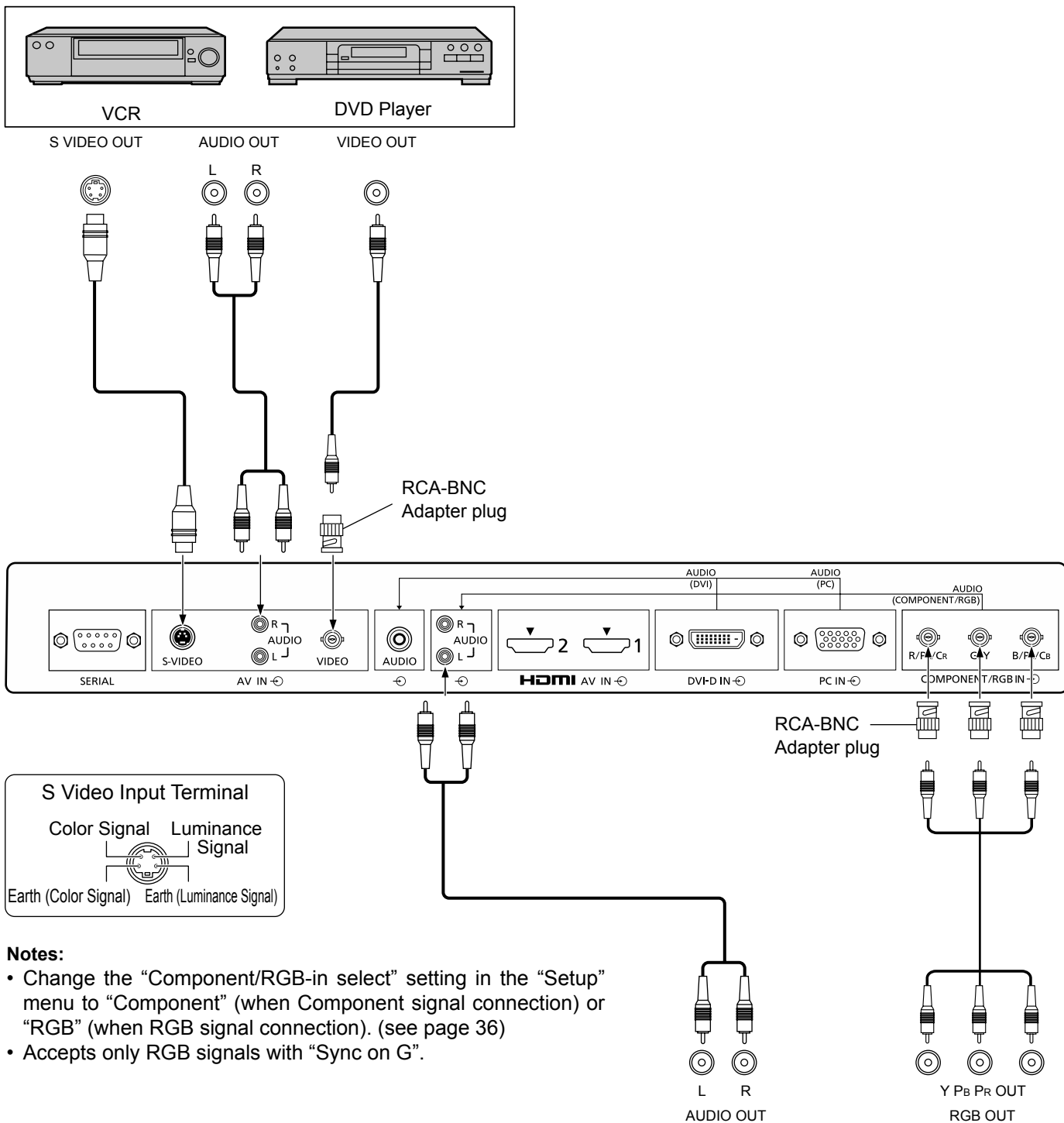

HDMI connection

[Pin assignments and signal names]

Pin No.	Signal Name	Pin No.	Signal Name
①	T.M.D.S Data2+	⑪	T.M.D.S Clock Shield
②	T.M.D.S Data2 Shield	⑫	T.M.D.S Clock-
③	T.M.D.S Data2-	⑬	CEC
④	T.M.D.S Data1+	⑭	Reserved (N.C. on device)
⑤	T.M.D.S Data1 Shield		
⑥	T.M.D.S Data1-	⑮	SCL
⑦	T.M.D.S Data0+	⑯	SDA
⑧	T.M.D.S Data0 Shield	⑰	DDC/CEC Ground
⑨	T.M.D.S Data0-	⑱	+5V Power
⑩	T.M.D.S Clock+	⑲	Hot Plug Detect

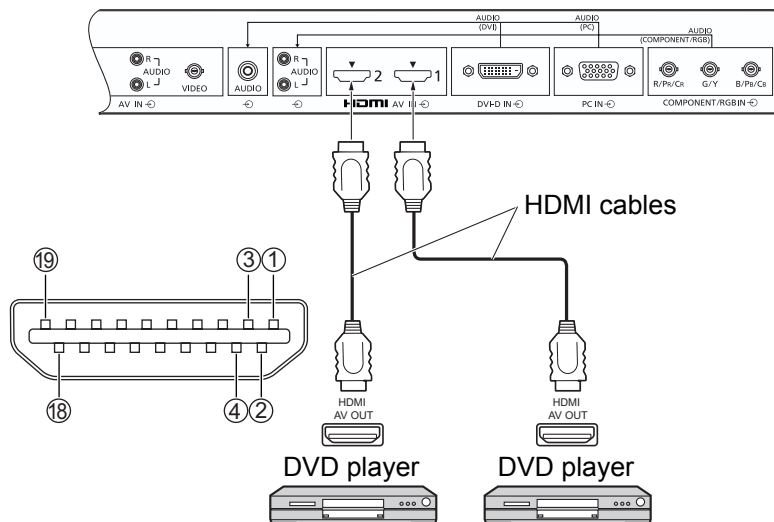

Note:

Additional equipment and HDMI cable shown are not supplied with this set.

DVI-D IN connection

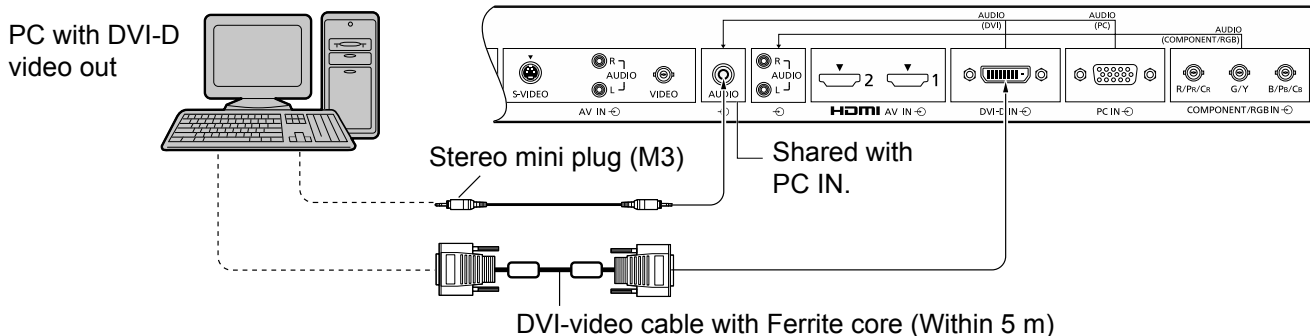

DVI-D Input Connector Pin Layouts

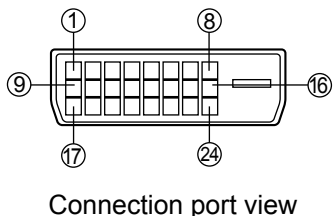

Pin No.	Signal Name	Pin No.	Signal Name
①	T.M.D.S. data 2-	⑬	_____
②	T.M.D.S. data 2+	⑭	+5 V DC
③	T.M.D.S. data 2 shield	⑮	Ground
④	_____	⑯	Hot plug detect
⑤	_____	⑰	T.M.D.S. data 0-
⑥	DDC clock	⑱	T.M.D.S. data 0+
⑦	DDC data	⑲	T.M.D.S. data 0 shield
⑧	_____	⑳	_____
⑨	T.M.D.S. data 1-	㉑	_____
⑩	T.M.D.S. data 1+	㉒	T.M.D.S. clock shield
⑪	T.M.D.S. data 1 shield	㉓	T.M.D.S. clock+
⑫	_____	㉔	T.M.D.S. clock-

Notes:

- Additional equipment and cables shown are not supplied with this set.
- Use the DVI-D cable with Ferrite core complying with the DVI standard. Image deterioration may occur depending on the length or the quality of the cable.

PC Input Terminals connection

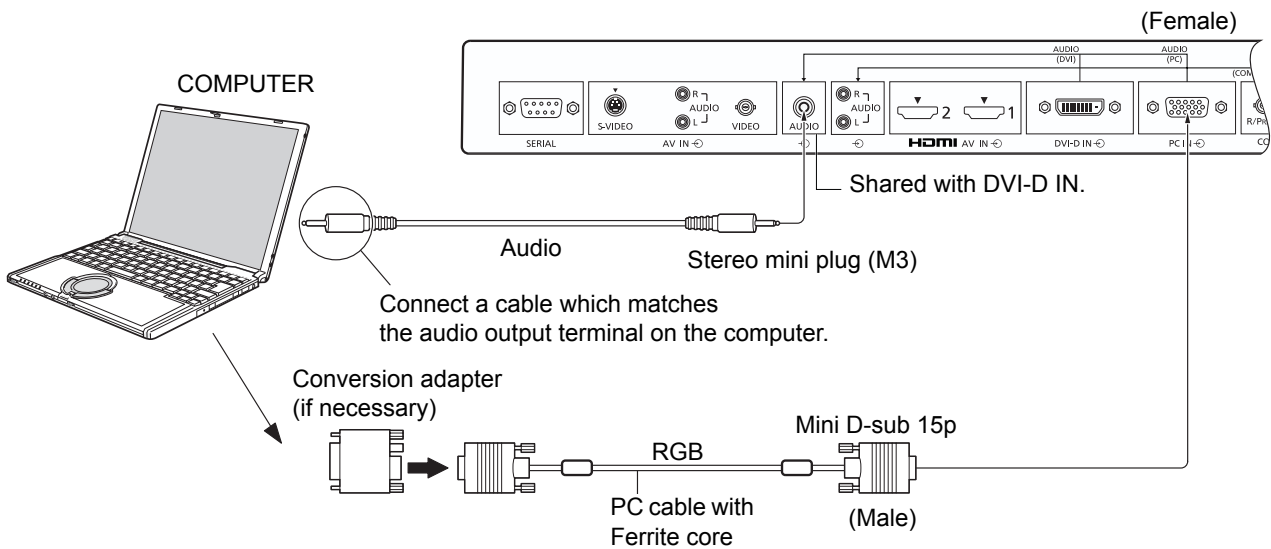

Notes:

- Computer signals which can be input are those with a horizontal scanning frequency of 30 to 110 kHz and vertical scanning frequency of 48 to 120 Hz. (However, the image will not be displayed properly if the signals exceed 1,200 lines.)
- The display resolution is a maximum of 1,440 × 1,080 dots when the aspect mode is set to “4:3”, and 1,920 × 1,080 dots when the aspect mode is set to “16:9”. If the display resolution exceeds these maximums, it may not be possible to show fine detail with sufficient clarity.
- The PC input terminals are DDC2B-compatible. If the computer being connected is not DDC2B-compatible, you will need to make setting changes to the computer at the time of connection.
- Some PC models cannot be connected to the set.
- There is no need to use an adapter for computers with DOS/V compatible Mini D-sub 15P terminal.
- The computer shown in the illustration is for example purposes only.
- Additional equipment and cables shown are not supplied with this set.
- Panasonic recommends using a PC cable that includes a Ferrite core.
- Do not set the horizontal and vertical scanning frequencies for PC signals which are above or below the specified frequency range.
- Component Input is possible with the pin 1, 2, 3 of the Mini D-sub 15P Connector.
- To use sync input VBS signals, use the connector which incorporates a 75-ohm termination resistance and which is available on the market, for the connection of the HD connector where the VBS signals are to be input.

Signal Names for Mini D-sub 15P Connector

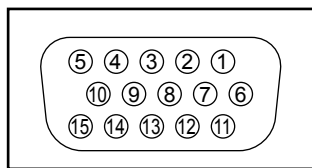

Pin Layout for PC Input Terminal

Pin No.	Signal Name	Pin No.	Signal Name	Pin No.	Signal Name
①	R	⑥	GND (Ground)	⑪	NC (not connected)
②	G	⑦	GND (Ground)	⑫	SDA
③	B	⑧	GND (Ground)	⑬	HD/SYNC
④	NC (not connected)	⑨	+5 V DC	⑭	VD
⑤	GND (Ground)	⑩	GND (Ground)	⑮	SCL

SERIAL Terminals connection

The SERIAL terminal is used when the Display is controlled by a computer.

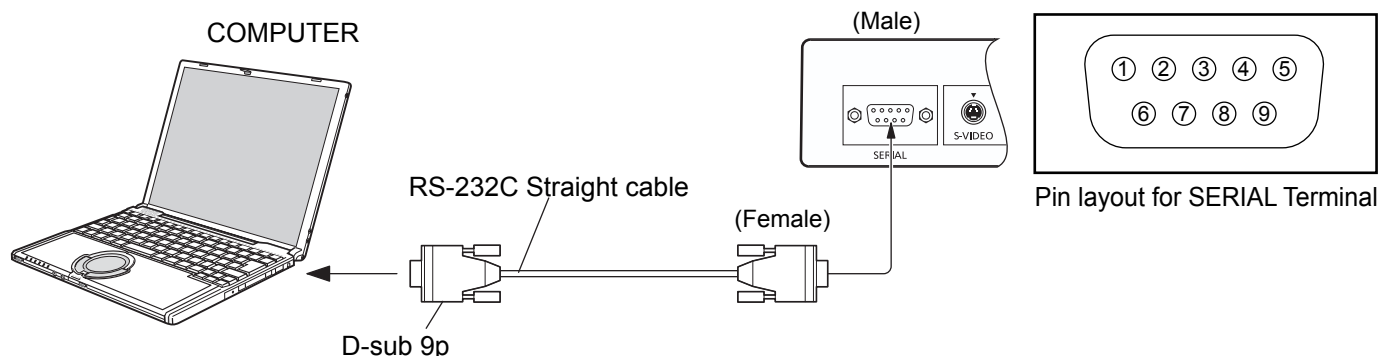

Notes:

- Use the RS-232C straight cable to connect the computer to the Display.
- The computer shown is for example purposes only.
- Additional equipment and cables shown are not supplied with this set.

The SERIAL terminal conforms to the RS-232C interface specification, so that the Display can be controlled by a computer which is connected to this terminal.

The computer will require software which allows the sending and receiving of control data which satisfies the conditions given below. Use a computer application such as programming language software. Refer to the documentation for the computer application for details.

Signal names for D-sub 9P connector

Pin No.	Details
②	R X D
③	T X D
⑤	GND
④ • ⑥	Non use
⑦ ⑧	↔ (Shorted in this set)
① • ⑨	NC

These signal names are those of computer specifications.

Communication parameters

Signal level	RS-232C compliant
Synchronization method	Asynchronous
Baud rate	9600 bps
Parity	None
Character length	8 bits
Stop bit	1 bit
Flow control	-

Basic format for control data

The transmission of control data from the computer starts with a STX signal, followed by the command, the parameters, and lastly an ETX signal in that order. If there are no parameters, then the parameter signal does not need to be sent.

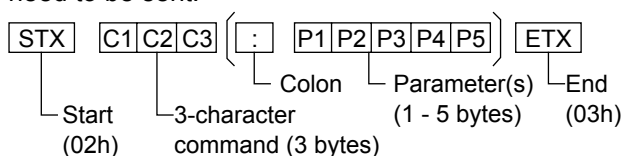

Notes:

- If multiple commands are transmitted, be sure to wait for the response for the first command to come from this unit before sending the next command.
- If an incorrect command is sent by mistake, this unit will send an "ER401" command back to the computer.

Command

Command	Parameter	Control details
PON	None	Power ON
POF	None	Power OFF
AVL	**	Volume 000 - 100
AMT	0	Audio MUTE OFF
	1	Audio MUTE ON
IMS	None	Input select (toggle)
	AV1	VIDEO input (VIDEO)
	AV2	COMPONENT/RGB IN input (Component)
	HM1	HDMI1 input (HDMI1)
	HM2	HDMI2 input (HDMI2)
DVI	DV1	DVI-D IN input (DVI)
	PC1	PC IN input (PC)
DAM	None	Screen mode select (toggle)
	ZOOM	Zoom1
	FULL	16:9
	NORM	4:3
	ZOM2	Zoom2

With the power off, this display responds to PON command only.

Power On / Off

Connecting the AC cord plug to the Display.

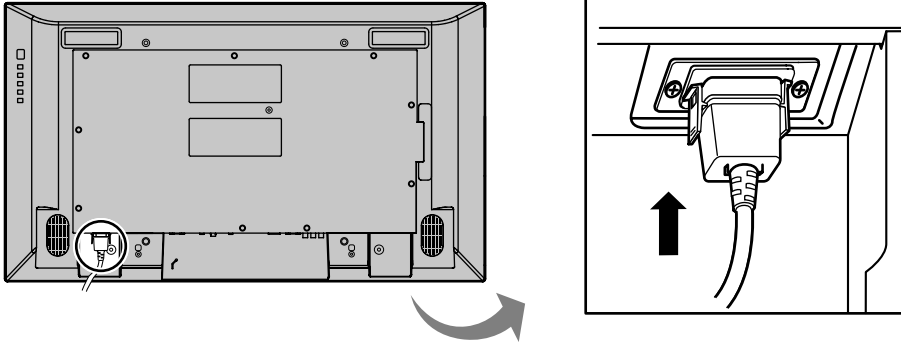

Connecting the plug to the Wall Outlet

Notes:

- Main plug types vary between countries. The power plug shown at right may, therefore, not be the type fitted to your set.
- When disconnecting the AC cord, be absolutely sure to disconnect the AC cord plug at the socket outlet first.

Press the Power switch on the Display to turn the set on: Power-On.

Power Indicator: Green

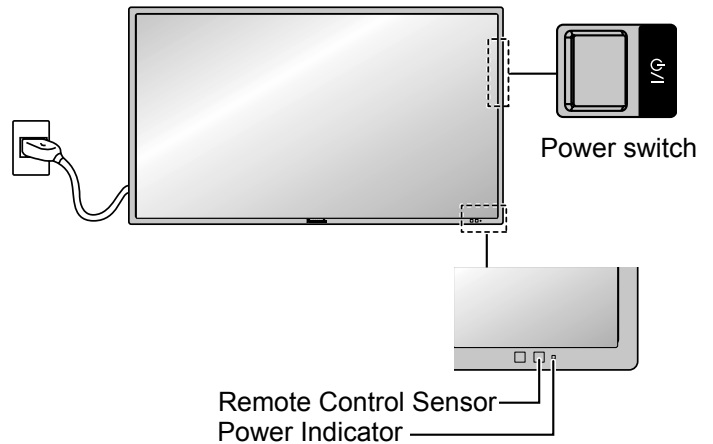

Press the  button on the remote control to turn the Display off.

Power Indicator: Red (standby)

Press the  button on the remote control to turn the Display on.

Power Indicator: Green

Turn the power to the Display off by pressing the /I switch on the unit, when the Display is on or in standby mode.

Note:

During operation of the power management function, the power indicator turns orange in the power off state.

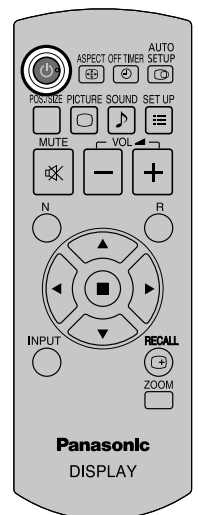

When first switching on the unit

Following screen will be displayed when the unit is turned on for the first time. Select the items with the remote control. Unit buttons are invalid.

OSD Language

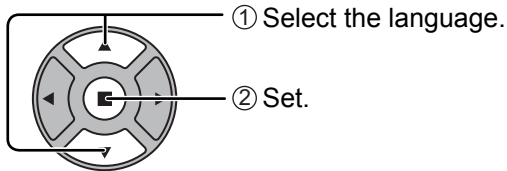

PRESENT TIME Setup

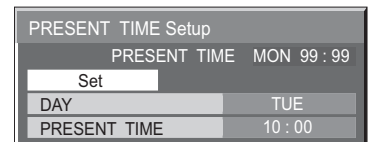
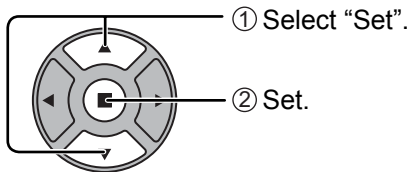
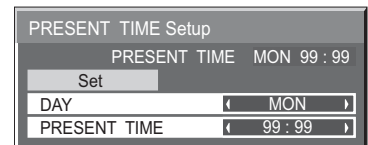
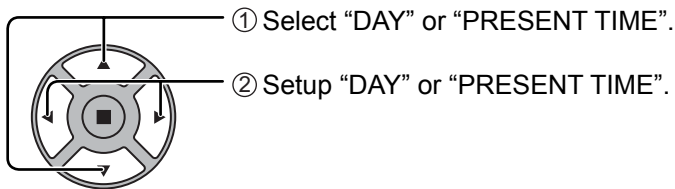

Notes:

- Once the items are set, the screens won't be displayed when switching on the unit next time.
- After the setting, the items can be changed in the following menus.
OSD Language (see page 33)
PRESENT TIME Setup (see page 27)

From the second time on, the below screen is displayed for a while (setting condition is an example).

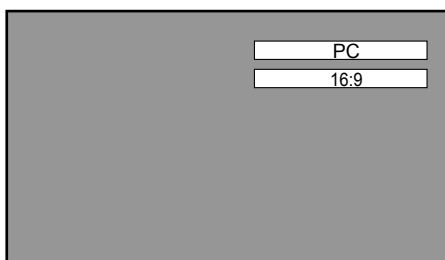

Selecting the input signal



Press to select the input signal to be played back from the equipment which has been connected to the Display.

Input signals will change as follows:

→ PC → DVI → HDMI1 → HDMI2 → VIDEO → Component*

PC: PC input terminal in PC IN.

DVI: DVI input terminal in DVI-D IN.

HDMI1: HDMI input terminal in AV IN (HDMI1).

HDMI2: HDMI input terminal in AV IN (HDMI2).

VIDEO: Video input terminal in AV IN (VIDEO/S-VIDEO).

Component*: Component or RGB input terminal in COMPONENT/RGB IN.

* "Component" may be displayed as "RGB" depending on the setting of "Component/RGB-in select". (see page 36)

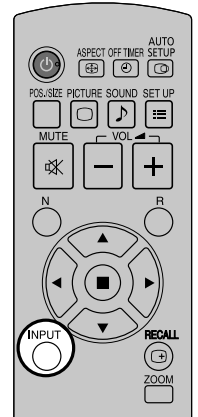

Notes:

- Selecting is also possible by pressing the INPUT button on the unit.
- Select to match the signals from the source connected to the component/RGB input terminals. (see page 36)

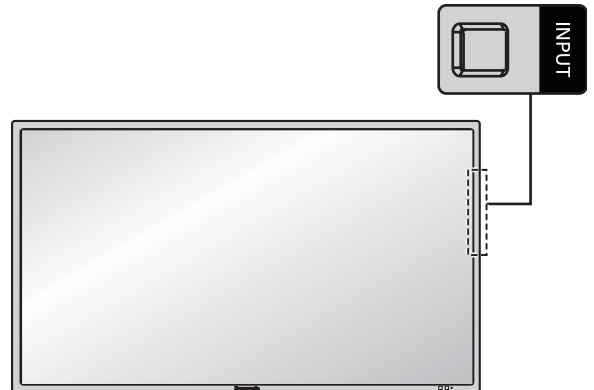

Basic Controls

Main Unit



Brightness Sensor

Detects the brightness in the viewing environment.

Remote control sensor

Power Indicator

The Power Indicator will light.

- Power-OFF Indicator not illuminated (The unit will still consume some power as long as the power cord is still inserted into the wall outlet.)
- Standby Red
- Power-ON Green
- Power management (DPMS) Orange (PC IN or DVI-D IN signal. See page 31)

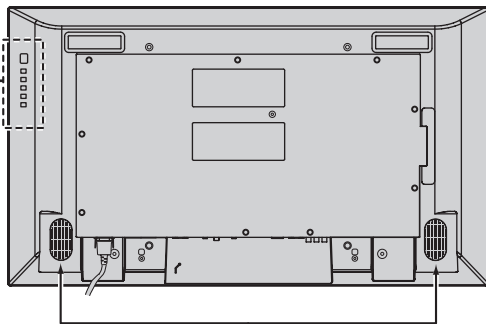

Speakers

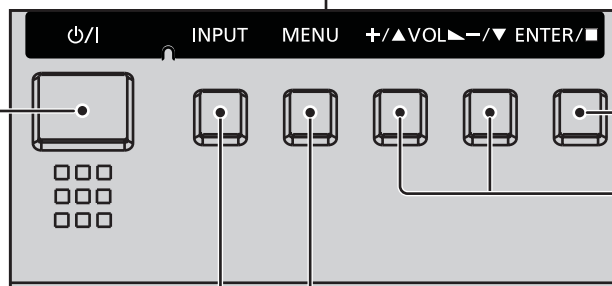

Main Power On / Off Switch

Enter / Aspect button

(see page 18, 20)

Volume Adjustment

Volume Up “+” Down “-”
When the menu screen is displayed:
“+”: press to move the cursor up
“-”: press to move the cursor down
(see page 20)

MENU Screen ON / OFF

Each time the MENU button is pressed, the menu screen will switch. (see page 20)

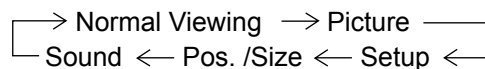

INPUT button

(INPUT signal selection)
(see page 15)

Remote Control Transmitter

ACTION button
Press to make selections.

ASPECT button
Press to adjust the aspect.
(see page 18)

Standby (ON / OFF) button
The Display must first be plugged into the wall outlet and turned on at the power switch (see page 13). Press this button to turn the Display On, from Standby mode. Press it again to turn the Display Off to Standby mode.

POS. /SIZE button
(see page 22)

PICTURE button
(see page 24)

Sound mute On / Off
Press this button to mute the sound.
Press again to reactivate sound.
Sound is also reactivated when power is turned off or volume level is changed.

N button
(see page 23, 24, 25, 26)

POSITION buttons

INPUT button
Press to select Input signal sequentially. (see page 15)

OFF TIMER button

The Display can be preset to switch to stand-by after a fixed period. The setting changes to 30 minutes, 60 minutes, 90 minutes and 0 minutes (off timer cancelled) each time the button is pressed.

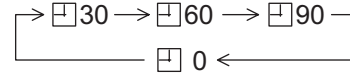

When three minutes remain, "Off timer 3" will flash.
The off timer is cancelled if a power interruption occurs.

AUTO SETUP button

Automatically adjusts the position/size of the screen. (see page 22)

SET UP button (see page 20)

SOUND button (see page 26)

Volume Adjustment

Press the Volume Up "+" or Down "-" button to increase or decrease the sound volume level.

R button (see page 20)

Press the R button to return to previous menu screen.

RECALL button

Press the "RECALL" button to display the current system status.

- ① Input label
- ② Aspect mode (see page 18)
- ③ Off timer

The off timer indicator is displayed only when the off timer has been set.

- ④ Clock display (see page 42)

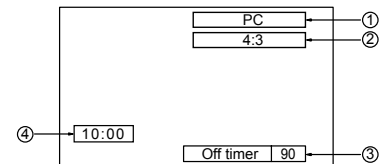

Digital Zoom (see page 19)

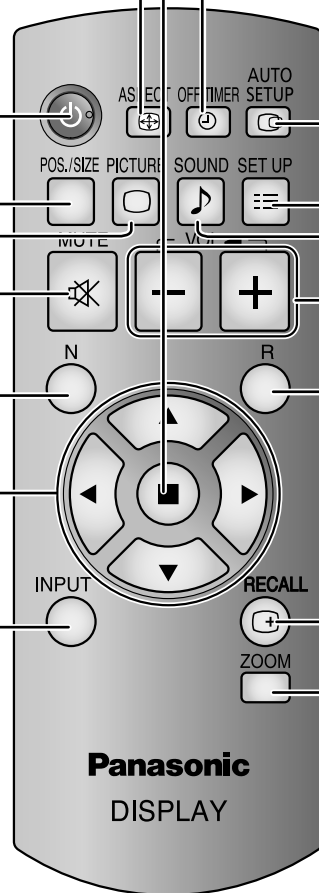

Panasonic
DISPLAY

ASPECT Controls

The Display will allow you to enjoy viewing the picture at its maximum size, including wide screen cinema format picture.

Note:

Be aware that if you put the display in a public place for commercial purposes or a public showing and then use the aspect mode select function to shrink or expand the picture, you may be violating the copyright under copyright law. It is prohibited to show or alter the copyrighted materials of other people for commercial purposes without the prior permission of the copyright holder.

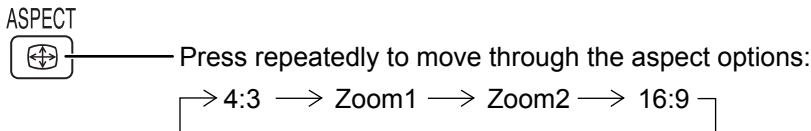
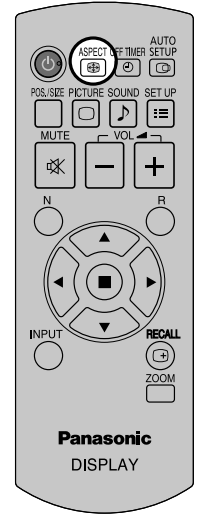

[from the unit]

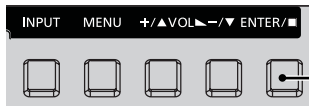

The aspect mode changes each time the ENTER button is pressed.

Note:

The aspect mode is memorized separately for each input terminal.

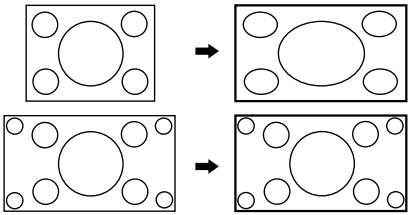
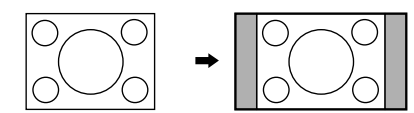
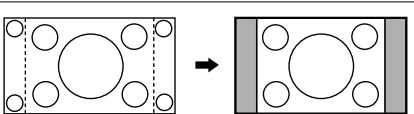
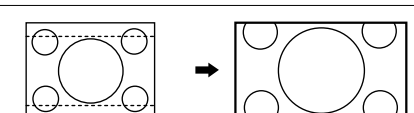
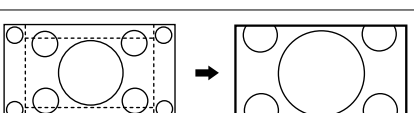
Aspect mode	Picture → Enlarged screen	Description
16:9		The display of the pictures fills the screen. In the case of SD signals, pictures with a 4:3 aspect ratio are enlarged horizontally, and displayed. This mode is suited to displaying anamorphic pictures with a 16:9 aspect ratio.
4:3		Pictures with a 4:3 aspect ratio are displayed with their original aspect ratio. Side panels are displayed at the left and right edges of the screen.
		The pictures with a 4:3 aspect ratio among the 16:9 aspect ratio signals are displayed with their original aspect ratio. The left and right edges of the pictures are masked with side panels.
Zoom1		Letterbox pictures with a 16:9 aspect ratio are enlarged vertically and horizontally so that their display fills the screen. The top and bottom edges of the pictures are cut off.
Zoom2		Letterbox pictures with a 16:9 aspect ratio are enlarged vertically and horizontally so that their display fills the screen. The top and bottom edges as well as the left and right edges of the pictures are cut off.

Digital Zoom

This displays an enlargement of the designated part of the displayed image.

1 Display the operation guide.

ZOOM
 Press to access Digital Zoom.
 The operation guide will be displayed.

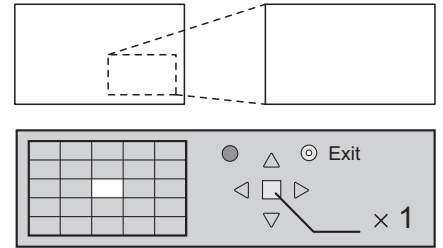

During Digital Zoom, only the following buttons can be operated.

[Remote control]

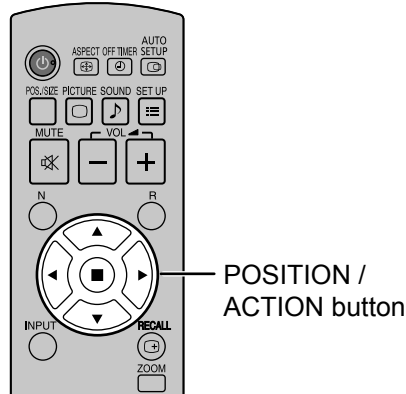

2 Select the area of the image to be enlarged.

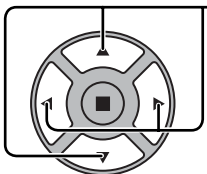
 Press on the enlargement location to select.
 The cursor will move.

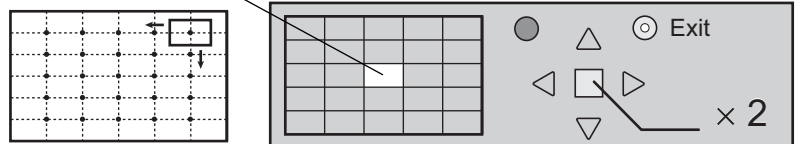

3 Select the magnification required for the enlarged display.

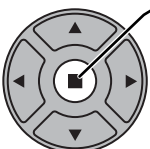
 Each time this is pressed, the magnification factor changes.
 This is shown in the image being displayed.

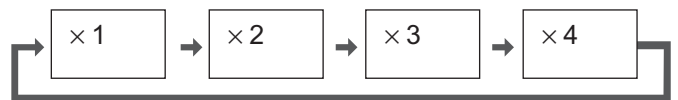

4 Return to normal display (quit Digital Zoom).

R
 Press to exit from the Digital Zoom.

Notes:

- When power goes OFF (including "Off Timer" operation), Digital Zoom terminates.
- The Digital Zoom function cannot be selected while in the following operation state:
 When MULTI DISPLAY Setup is On (see page 34).
 When Screensaver is running (see page 29)
- While Digital Zoom is in operation, "Adjusting Pos. / Size" cannot be used.

On-Screen Menu Displays

Remote Control

Unit

1 Display the menu screen.

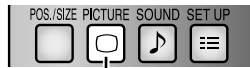

Press to select.
(Example: Picture menu)

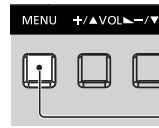

Press several times.
Each time the MENU button is pressed, the menu screen will switch.

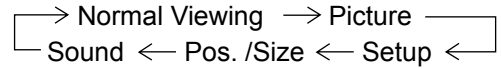

2 Select the item.

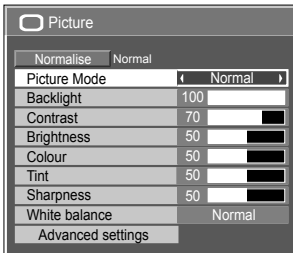

(Example: Picture menu)

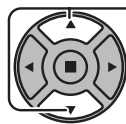

Select.

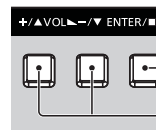

2 Press.

1 Select.

3 Set.



Adjust.

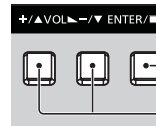

2 Press.

1 Adjust.

4 Exit the menu.

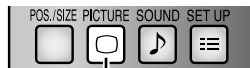

Press.
Press R to return to the previous menu.

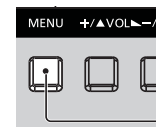

Press several times.

Overview

Note: Menu that cannot be adjusted is grayout. Adjustable menu changes depending on signal, input and menu setting.

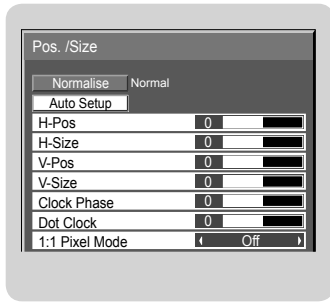

Page 22, 23

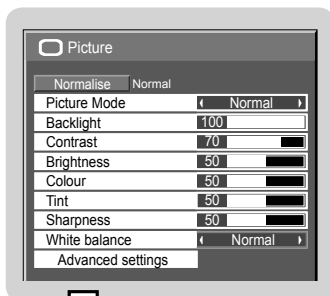

Page 24, 25

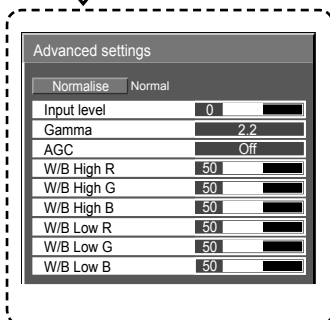

Page 24, 25

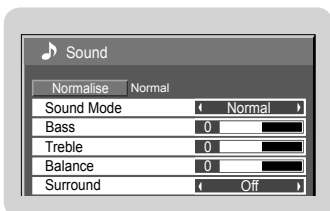

Page 26

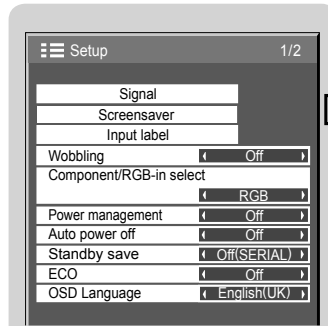

Page 27-40

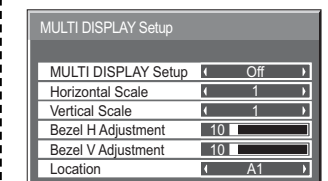
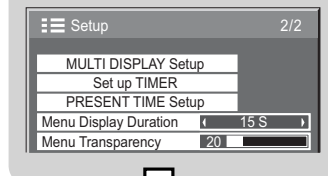

Page 34, 35

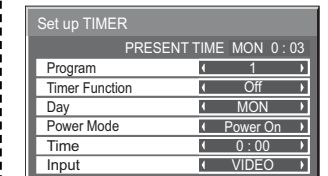

Page 28

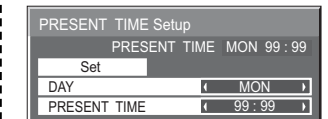

Page 27

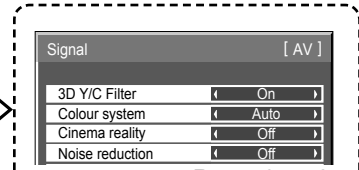

Page 37-40



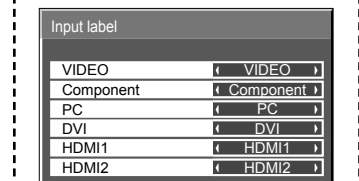

Page 29, 30

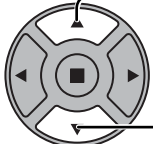
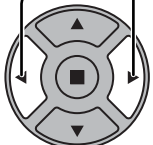

Page 32

Adjusting Pos. /Size

- 1  Press to display the Pos. /Size menu.
- 2  Press to select the menu to adjust.
- 3  Press to adjust the menu.
- 4  Press to exit from adjust mode.

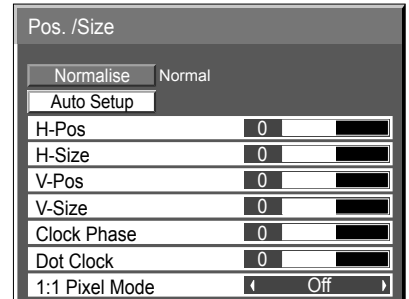

Notes:

Unadjustable items are grayed out.

Adjustable items differ depending on the input signal and the display mode.

Note:

If a "Cue" or "Rew" signal from a VCR or DVD player is received, the picture position will shift up or down. This picture position movement cannot be controlled by the Picture Pos./Size function.

Auto Setup H-Pos/V-Pos, H-Size/V-Size, Dot Clock and Clock Phase are automatically adjusted when the RGB or PC signal is received.

This setting only operates when a PC signal or RGB signal is input, and the aspect is "16:9".

Using Remote Control

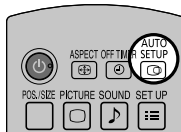

When  on the remote control is pressed, "Auto Setup" will be executed.

When Auto Setup does not work, "Invalid" is displayed.

Notes:

- When digital RGB signal input, Dot Clock and Clock Phase cannot be made.
- Auto Setup may not work when a cropped or dark image is input. In such case, switch to a bright image with borders and other objects are clearly shown, and then try auto setup again.
- Depending on the signal, out of alignment may occur after Auto Setup. Carry out fine tuning for the position/size as required.
- If Auto Setup cannot set properly for vertical frequency 60Hz XGA signal (1024×768@60Hz and 1366×768@60Hz), pre-selecting the individual signal in "XGA Mode" (see page 38) may results in correct Auto Setup.
- Auto Setup does not work well when a signal such as additional information is superimposed out of valid image period or intervals between synchronizing and image signals are short.
- If Auto Setup cannot adjust correctly, select "Normalise" once and press ACTION (■), then adjust Pos. /Size manually.
- If the picture goes off screen in the horizontal direction as a result of performing Auto Setup, perform Dot Clock adjustment.

H-Pos

Adjust the horizontal position.

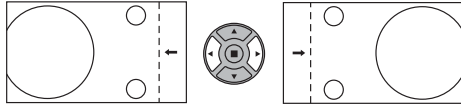

V-Pos

Adjust the vertical position.

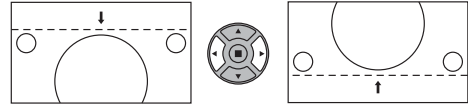

H-Size

Adjust the horizontal size.

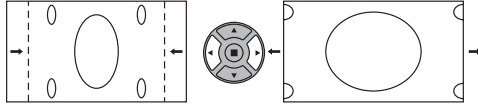

V-Size

Adjust the vertical size.

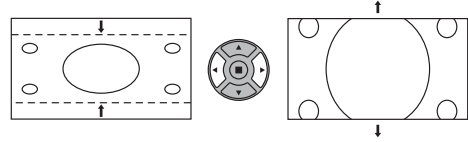

Clock Phase

(During Component, RGB and PC input signal)

Eliminate the flickering and distortion.

Dot Clock

(During Component, RGB and PC input signal)

Periodic striped pattern interference (noise) may occur when a striped pattern is displayed. If this happens, adjust so that any such noise is minimized.

Over scan

Turn image over scan On/Off.

Configurable signals are as follows:

525i, 525p, 625i, 625p, 750/60p, 750/50p (Component Video, DVI, HDMI)

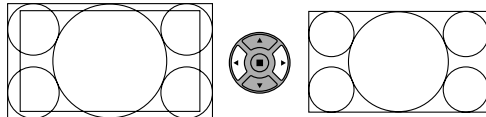

On

Off

Notes:

- "Off" is effective during only "16:9" aspect mode.
- When "Off" is set, "H-Size" and "V-Size" cannot be adjusted.

1:1 Pixel Mode

Adjusts the display size when 1125i, 1125p or 1250i signal is input.

Notes:

- "On" is effective during only "16:9" aspect mode.
- Select On when you would like to replay 1920 × 1080 input signal.
- Applicable input signal;
1125 (1080) / 50i · 60i · 24sF · 24p · 25p · 30p · 50p · 60p
- Select Off when flickering is shown around the image.
- H-Size and V-Size cannot be adjusted when On is selected.

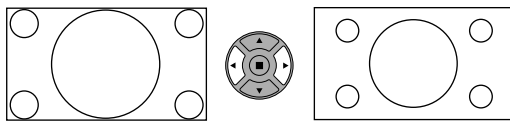

Off

On

Helpful Hint (/ **Normalise** Normalisation)

While the Pos. / Size display is active, if either the N button on the remote control is pressed at any time or the ACTION (■) button is pressed during "Normalise", then all adjustment values (except "Clock Phase" and "Dot Clock") are returned to the factory settings.

Picture Adjustments

1  Press to display the Picture menu.

2 Select to adjust each item.

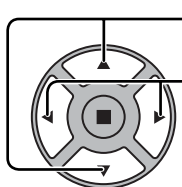
 Press to select the menu to adjust.
 Select the desired level by looking at the picture behind the menu.

Note:
 Menu that cannot be adjusted is grayout. Adjustable menu changes depending on signal, input and menu setting.

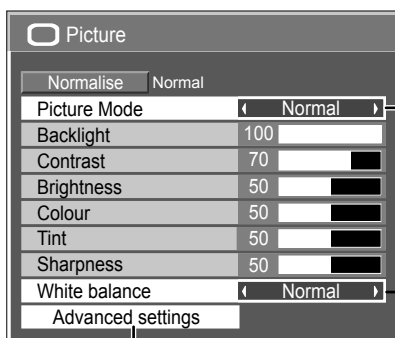

Press “◀” or “▶” button to switch between modes.



Normal
 For viewing in standard (evening lighting) environments.
 This menu selects the normal levels of Brightness and Contrast.

Dynamic
 For viewing in brighter environments.
 This menu selects higher than normal levels of Brightness and Contrast.

Cinema
 Ideal for movies.

Note:
 If you would like to change the picture and colour of the selected Picture menu to something else, adjust using the items in the Picture menu. (see next page)

 Press to enter Advanced settings .

Advanced settings
 Enables fine picture adjustment at a professional level (see next page).

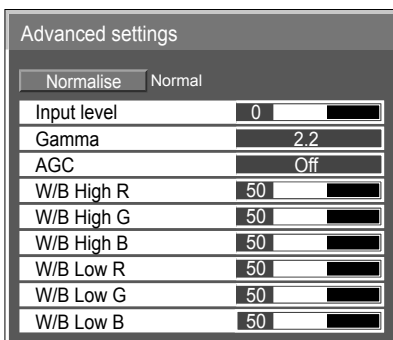

Press “◀” or “▶” button to switch between modes.

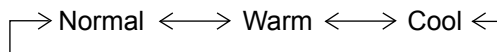

Helpful Hint (/ Normalisation)

While the “Picture” menu is displayed, if either the N button on the remote control is pressed at any time or the ACTION () button is pressed during “Normalise”, then all adjustment values are returned to the factory settings.

Picture Adjustments

Item	Effect	Adjustments
Backlight	Darker Brighter	Adjusts luminance of the back light.
Contrast	Less More	Selects the proper brightness and density for the room.
Brightness	Darker Brighter	Adjusts for easier viewing of dark pictures such as night scenes and black hair.
Colour	Less More	Adjusts colour saturation.
Tint	Reddish Greenish	Adjusts for nice skin colour.
Sharpness	Less More	Adjusts picture sharpness.

Notes:

- “Colour” setting can be adjusted for Video input signal.
- You can change the level of each function (Backlight, Contrast, Brightness, Colour, Tint, Sharpness) for each Picture Mode.
- The setting details for normal, dynamic and cinema respectively are memorized separately for each input terminal.
- The “Tint” setting can be adjusted for NTSC signal only during Video (S Video) input signal.
- In Contrast, there is not a noticeable change even when contrast is increased with a bright picture or reduced with a dark picture.

Advanced settings

Item	Effect	Details
Input level	Less More	Adjustment of parts which are extremely bright and hard to see.
Gamma	Down Up	S Curve \longleftrightarrow 2.0 \longleftrightarrow 2.2 \longleftrightarrow 2.6
AGC	Off On	Increases the brightness of dark signal automatically.
W/B High R	Less More	Adjusts the white balance for light red areas.
W/B High G	Less More	Adjusts the white balance for light green areas.
W/B High B	Less More	Adjusts the white balance for light blue areas.
W/B Low R	Less More	Adjusts the white balance for dark red areas.
W/B Low G	Less More	Adjusts the white balance for dark green areas.
W/B Low B	Less More	Adjusts the white balance for dark blue areas.

Notes:

- Carry out “W/B” adjustment as follows.
 1. Adjust the white balance of the bright sections using the “W/B High R”, “W/B High G” and “W/B High B” settings.
 2. Adjust the white balance of the dark sections using the “W/B Low R”, “W/B Low G” and “W/B Low B” settings.
 3. Repeat steps 1 and 2 to adjust.
 Steps 1 and 2 affect each other’s settings, so repeat each step in turn to make the adjustment.
- The adjustment values are memorized separately for each input terminal.
- The adjustment range values should be used as an adjustment reference.

Helpful Hint (/ **Normalise** **Normalisation**)

On the remote control unit, while the “Advanced settings” menu is displayed, if either the N button is pressed at any time or the ACTION () button is pressed during “Normalise”, then all adjustment values are returned to the factory settings.

Sound Adjustment

1  Press to display the Sound menu.

2 Select to adjust each item.

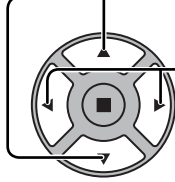
 Press to select the menu to adjust.
Select the desired level by listening to the sound.

3  Press to exit from adjust mode.

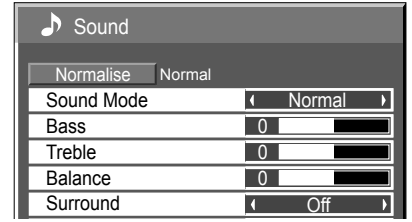

Item	Details
Sound Mode	Normal: Emits the original sound. Dynamic: Accentuates sharp sound. Clear: Attenuates human voice.
Bass	Adjusts low pitch sounds.
Treble	Adjusts high pitch sounds.
Balance	Adjusts left and right volumes.
Surround	Select On or Off.

Note: Bass, Treble and Surround settings are memorized separately for each Sound Mode.

Helpful Hint (/ Normalisation)

While the "Sound" menu is displayed, if either the N button on the remote control is pressed at any time or the ACTION () button is pressed during "Normalise", then all adjustment values are returned to the factory settings.

PRESENT TIME Setup / Set up TIMER

The timer can switch the Display On or Off.

Before attempting Timer Set, confirm the PRESENT TIME and adjust if necessary.
Then set POWER ON Time / POWER OFF Time.

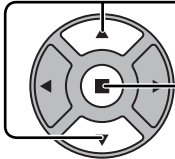
-  Press to display the Setup menu.
-  Press to select Set up TIMER or PRESENT TIME Setup.
Press to display the Set up TIMER screen or PRESENT TIME Setup screen.

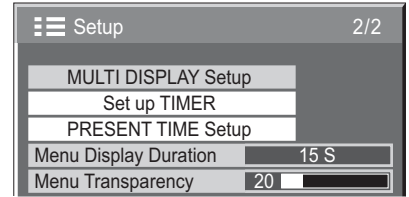

PRESENT TIME Setup

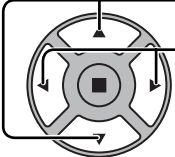
-  Press to select DAY or PRESENT TIME.
Press to setup DAY or PRESENT TIME.
▶ button: Forward
◀ button: Back

Notes:

- Pressing “◀” or “▶” button once changes PRESENT TIME 1 minute.
- Pressing “◀” or “▶” button continuously changes PRESENT TIME by 15 minutes.

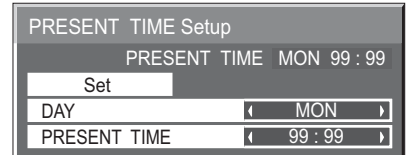

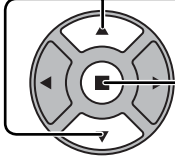
-  Press to select Set.
Press to store PRESENT TIME Setup.

Notes:

- Set cannot be selected unless PRESENT TIME is set.
- Unless setting the present time other than “99:99”, “DAY” and “PRESENT TIME” can not be set.
- The settings of “DAY” and “PRESENT TIME” are reset when leaving the display turned off for about 7 days for the following reasons:
Pressing  switch of the unit to turn off the display.
Disconnecting the AC cord.
Interruption of power supply.

Set up TIMER

Set the program for turning the power On/Off and select the input signal at the specified time. Up to 20 programs can be set.

[Setting Example]

Program 1, Every Monday, 12:00, Power On, Input: VIDEO

Set up TIMER	
PRESENT TIME MON 0 : 03	
Program	1
Timer Function	On
Day	MON
Power Mode	Power On
Time	12 : 00
Input	VIDEO

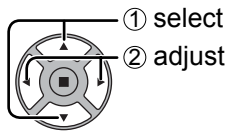

- 1 Set the program number.
- 2 To execute the program, set to "On".
The program is disabled when "Off" is set.
- 3 Set the day.
The program is executed every day when "Everyday" is set.
- 4 Set the power On/Off.
- 5 Set the time.
Pressing "◀" or "▶" button once changes "Time" 1 minute.
Pressing "◀" or "▶" button continuously changes "Time" by 15 minutes.
- 6 Set the input.

Notes:

- This function cannot be set unless "PRESENT TIME Setup" is set.
- If more than one programs are set for the same time, only the program with the smallest program number is enabled.

Screensaver (For preventing image retention)

Do not display a still picture, especially in 4:3 mode, for any length of time.

If the display must remain on, a Screensaver should be used.

When the screen saver is operating, the following 5 patterns are displayed full screen for 5 seconds each.

Black→Dark Gray→Gray→Light Gray→White

1  Press to display the Setup menu.

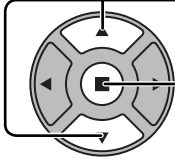
2  Press to select Screensaver.
Press to display Screensaver screen.

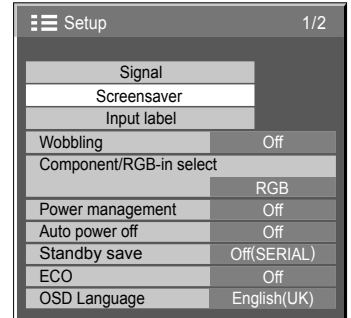

3 Mode selection

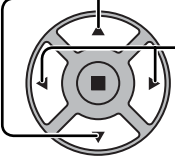
 Press to select Mode.
Press to select each mode items.

- Off
- Interval : Operates when Periodic Time and Operating Time are setup and those times arrive.
- Time Designation : Operates when Start Time and Finish Time are setup and those times arrive.
- Standby after SCR Saver: Operates while Screensaver duration, and display enters standby mode.
- On : Operates when Start is selected and the ACTION (■) button is pressed.

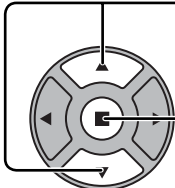

4 Start setting

 When the Mode is set to On, press to select Start.
Press to start Screensaver.

The menu screen will disappear and the Screensaver will be activated. **To stop the Screensaver under On, press the R button or any buttons on the main unit.**

Note: When the display is turned off, the Screensaver will be deactivated.

Setup of Screensaver Time

After selecting Time Designation, Interval or Standby after SCR Saver, the relevant Time Setup will become available for selection and the Operating Time may be set. (Time cannot be set when “Mode” is “On” or “Off”).

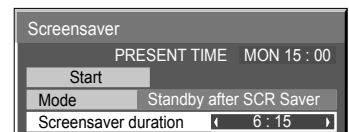
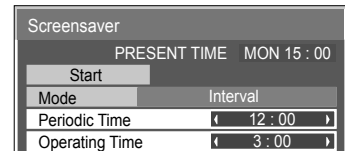
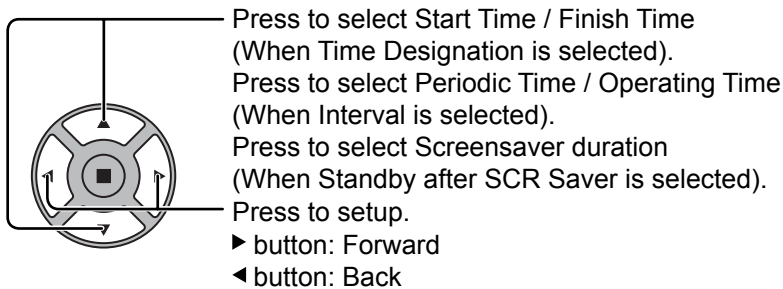

Notes:

- Pressing “◀” or “▶” button once changes the Time 1 minute.
[However, switching occurs every 15 minutes when Periodic Time is selected.]
- Pressing “◀” or “▶” button continuously changes the Time by 15 minutes.
- “Screensaver duration” of the “Standby after SCR Saver” can be set from 0:00 to 23:59. When this is set to “0:00”, “Standby after SCR Saver” will not be activated.

Note: Timer function will not work unless “PRESENT TIME” is set.

Wobbling

Automatically shifts the display image (therefore unnoticeable to the eye) to prevent image retention of sharper contour of image.

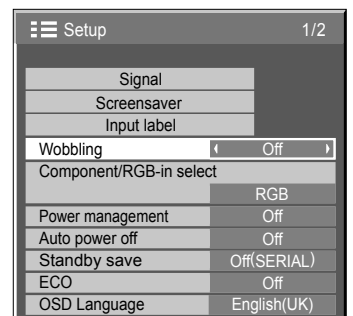
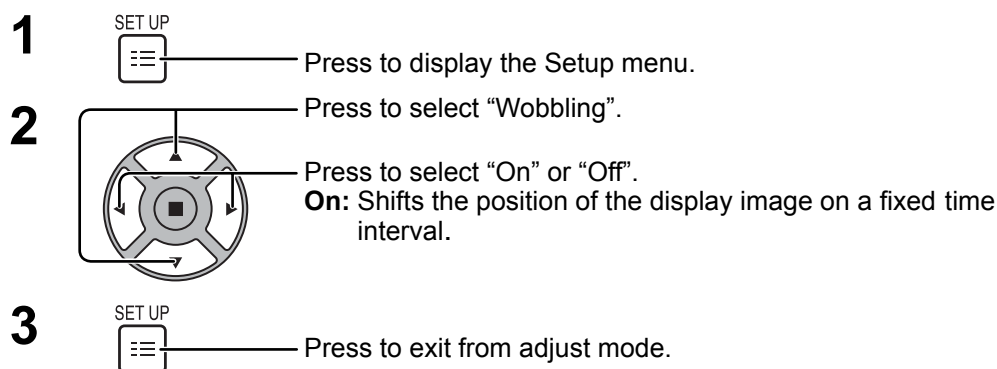

Notes:

- If “MULTI DISPLAY Setup” is set to “On”, this function does not operate.
- When this function is operating, part of the screen may appear to be missing.

Reduces power consumption

- Power management:**

When this function is set to On, it operates under the following conditions to turn the power on or off automatically.

When no pictures are detected for 30 or so seconds during input from PC IN or DVI-D IN terminal:
 → Power is turned off (standby); the power indicator lights up orange.

When pictures are subsequently detected:
 → Power is turned on; the power indicator lights up green.

Notes:

 - This function operates only during input from PC IN or DVI-D IN terminal.
 - This function is effective when “Sync” is set to “Auto” and during normal viewing (one picture screen).
- Auto power off:**

Equipment power supply is turned Off when there is no signal.

When this is set to On, the power supply of the unit goes Off 10 minutes after the input signals stop.

Note:

This function is effective during normal viewing (one picture screen).
- Standby save:**

When this function is set to “On”, serial communication is disabled during standby mode, reducing the power consumption during standby.

To perform serial communication while in standby, set this function to “Off(SERIAL)”. However, the standby power consumption is greater than when it is set to “On”.
- ECO:**

This function adjusts the brightness of the backlight to reduce power consumption.

Off: This function does not operate.
 On: Backlight brightness is reduced.
 Sensor: The backlight brightness is automatically adjusted according to the viewing environment.

Note:

When this function is set to “On” or “Sensor”, the “Backlight” setting in the Picture menu is disabled.

1 Press to select the menu to adjust.

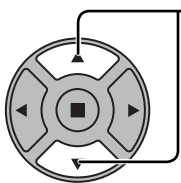

2 Press to select “On” or “Off”.

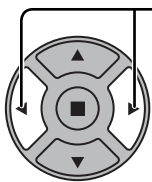

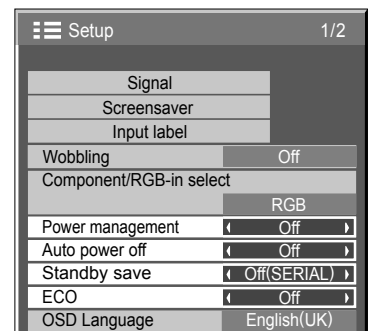

On ← → Off

3 Press to exit from Setup.

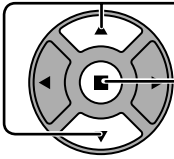
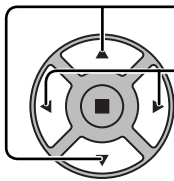
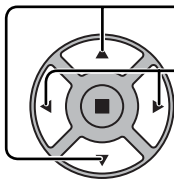

Customizing the Input labels

This function can change the label of the Input signal to be displayed. (see page 15)

- 1  Press to display the Setup menu.
- 2  Press to select Input label.
 Press to display the Input label screen.
- 3  Press to select image input.
 Press to change input label.

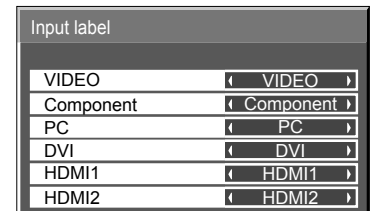
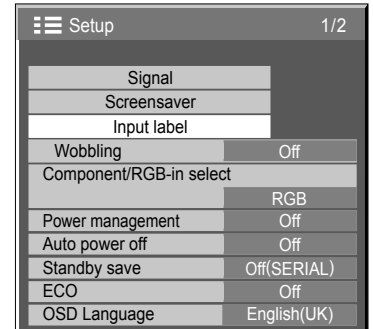

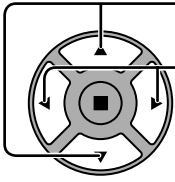

Image input	Input label
[VIDEO]	VIDEO / DVD1 / DVD2 / DVD3 / Blu-ray1 / Blu-ray2 / Blu-ray3 / CATV / VCR / STB / (Skip)
[Component]*	Component / DVD1 / DVD2 / DVD3 / Blu-ray1 / Blu-ray2 / Blu-ray3 / CATV / VCR / STB / (Skip)
[PC]	PC / DVD1 / DVD2 / DVD3 / Blu-ray1 / Blu-ray2 / Blu-ray3 / CATV / VCR / STB / (Skip)
[DVI]	DVI / DVD1 / DVD2 / DVD3 / Blu-ray1 / Blu-ray2 / Blu-ray3 / CATV / VCR / STB / (Skip)
[HDMI1]	HDMI1 / DVD1 / DVD2 / DVD3 / Blu-ray1 / Blu-ray2 / Blu-ray3 / CATV / VCR / STB / (Skip)
[HDMI2]	HDMI2 / DVD1 / DVD2 / DVD3 / Blu-ray1 / Blu-ray2 / Blu-ray3 / CATV / VCR / STB / (Skip)

(Skip): The INPUT button press will skip its input.

* "Component" may be displayed as "RGB" depending on the setting of "Component/RGB-in select". (see page 36)

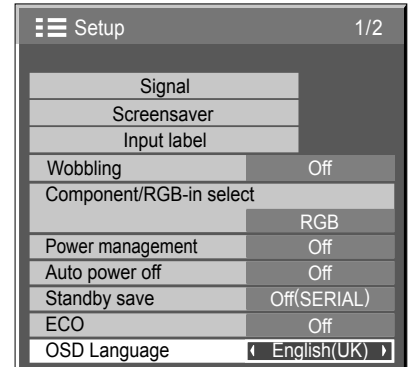

Selecting the On-Screen Menu Language

-  Press to display the Setup menu.
 - 
 - Press to select the OSD Language.
 - Press to select your preferred language.
- Selectable languages
- English (UK)
 - ↕
 - Deutsch
 - ↕
 - Français
 - ↕
 - Italiano
 - ↕
 - Español
 - ↕
 - English (US)
 - ↕
 - 中文.....(Chinese)
 - ↕
 - 日本語.....(Japanese)
 - ↕
 - Русский.....(Russian)

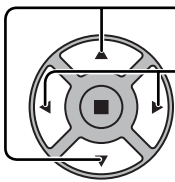
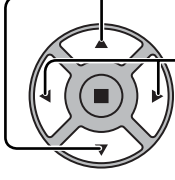

Customizing the On-Screen Menu Display

Set the display time and background transparency of the on-screen menu display.

-  Press to display the Setup menu.
- 
 - Press to select "Menu Display Duration".
 - Press to adjust the display duration.
- 
 - Press to select "Menu Transparency".
 - Press to adjust the transparency.
-  Press to exit from adjust mode.

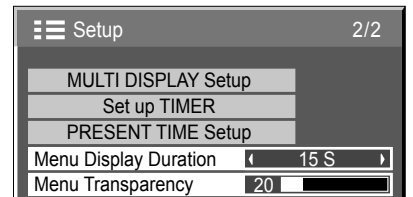

Setup for MULTI DISPLAY

By lining up the Displays in groups, for example, as illustrated below, an enlarged picture may be displayed across all screens.

For this mode of operation, each display has to be set up with a Display number to determine its location.

(Example)

group of 4 (2 × 2)



group of 9 (3 × 3)







group of 16 (4 × 4)



group of 25 (5 × 5)

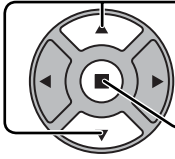

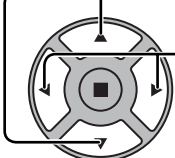
How to Setup MULTI DISPLAY

- 1  Press to display the Setup menu.
- 2  Press to select the MULTI DISPLAY Setup.
 Press to display the "MULTI DISPLAY Setup" menu.
- 3  Press to select the MULTI DISPLAY Setup.
 Press to select "On" or "Off".

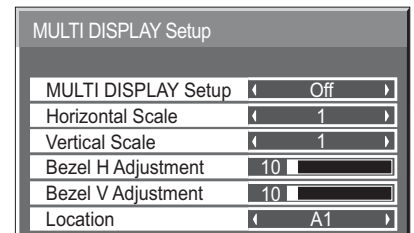
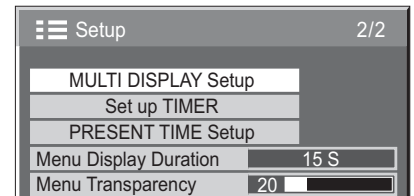

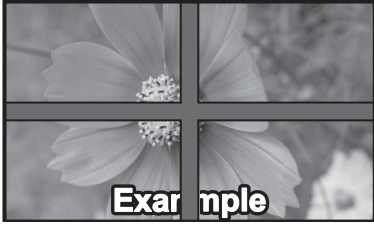
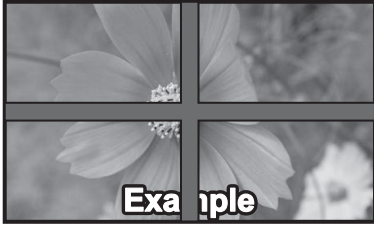
Item	Details
MULTI DISPLAY Setup	Select "On" or "Off".
Horizontal Scale	Select "1", "2", "3", "4", "5".
Vertical Scale	Select "1", "2", "3", "4", "5".
Bezel H Adjustment Bezel V Adjustment	<p>Areas of the image that are hidden by the joint sections are adjusted both horizontally and vertically (0~100).</p> <div style="display: flex; justify-content: space-around;"> <div style="text-align: center;"> <p>To show joints between displays.</p>  <p>Example</p> <p>Suitable for still image display. Setting value: 0</p> </div> <div style="text-align: center;"> <p>To hide joints between displays.</p>  <p>Example</p> <p>Suitable for moving image display. Setting value: 100</p> </div> </div>

Item	Details																																																								
Location	Select the required arrangement number. (A1-E5 : Refer to the following)																																																								
	<p>Display Number locations for each arrangement.</p> <p>(Examples)</p> <div style="display: flex; justify-content: space-around; align-items: flex-start;"> <div style="text-align: center;"> <p>(2 × 1)</p> <table border="1" style="margin: 0 auto;"> <tr><td>A1</td><td>A2</td></tr> </table> </div> <div style="text-align: center;"> <p>(2 × 3)</p> <table border="1" style="margin: 0 auto;"> <tr><td>A1</td><td>A2</td></tr> <tr><td>B1</td><td>B2</td></tr> <tr><td>C1</td><td>C2</td></tr> </table> </div> <div style="text-align: center;"> <p>(4 × 2)</p> <table border="1" style="margin: 0 auto;"> <tr><td>A1</td><td>A2</td><td>A3</td><td>A4</td></tr> <tr><td>B1</td><td>B2</td><td>B3</td><td>B4</td></tr> </table> </div> <div style="text-align: center;"> <p>(4 × 4)</p> <table border="1" style="margin: 0 auto;"> <tr><td>A1</td><td>A2</td><td>A3</td><td>A4</td></tr> <tr><td>B1</td><td>B2</td><td>B3</td><td>B4</td></tr> <tr><td>C1</td><td>C2</td><td>C3</td><td>C4</td></tr> <tr><td>D1</td><td>D2</td><td>D3</td><td>D4</td></tr> </table> </div> <div style="text-align: center;"> <p>(5 × 5)</p> <table border="1" style="margin: 0 auto;"> <tr><td>A1</td><td>A2</td><td>A3</td><td>A4</td><td>A5</td></tr> <tr><td>B1</td><td>B2</td><td>B3</td><td>B4</td><td>B5</td></tr> <tr><td>C1</td><td>C2</td><td>C3</td><td>C4</td><td>C5</td></tr> <tr><td>D1</td><td>D2</td><td>D3</td><td>D4</td><td>D5</td></tr> <tr><td>E1</td><td>E2</td><td>E3</td><td>E4</td><td>E5</td></tr> </table> </div> </div>	A1	A2	A1	A2	B1	B2	C1	C2	A1	A2	A3	A4	B1	B2	B3	B4	A1	A2	A3	A4	B1	B2	B3	B4	C1	C2	C3	C4	D1	D2	D3	D4	A1	A2	A3	A4	A5	B1	B2	B3	B4	B5	C1	C2	C3	C4	C5	D1	D2	D3	D4	D5	E1	E2	E3	E4
A1	A2																																																								
A1	A2																																																								
B1	B2																																																								
C1	C2																																																								
A1	A2	A3	A4																																																						
B1	B2	B3	B4																																																						
A1	A2	A3	A4																																																						
B1	B2	B3	B4																																																						
C1	C2	C3	C4																																																						
D1	D2	D3	D4																																																						
A1	A2	A3	A4	A5																																																					
B1	B2	B3	B4	B5																																																					
C1	C2	C3	C4	C5																																																					
D1	D2	D3	D4	D5																																																					
E1	E2	E3	E4	E5																																																					

4



Press to exit from Setup.

Setup for Input Signals

Component / RGB-in select

Select to match the signals from the source connected to the COMPONENT/RGB IN terminal.

Y, P_B, P_R signals ⇒ "Component"

RGB signals ⇒ "RGB"

1  Press to display the Setup menu.

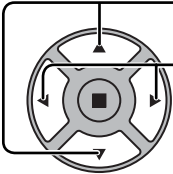
2  Press to select the "Component / RGB-in select".
Press to select the desired input signal.
Component ← → RGB

3  Press to exit from adjust mode.

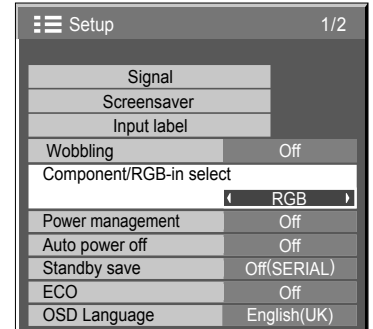

Setup 1/2	
Signal	
Screensaver	
Input label	
Wobbling	Off
Component/RGB-in select	RGB
Power management	Off
Auto power off	Off
Standby save	Off(SERIAL)
ECO	Off
OSD Language	English(UK)



Note:

Make setting of the selected input terminal (COMPONENT/RGB IN).

Signal menu

Note:

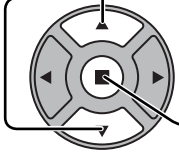
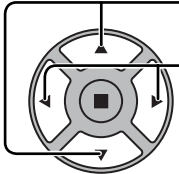
“Signal” setup menu displays a different setting condition for each input signal.

- 1  Press to display the Setup menu.
- 2  Press to select the “Signal”.
Press to display the Signal menu.
- 3  Press to select the menu to adjust.
Press to adjust the menu.
- 4  Press to exit from adjust mode.

Setup 1/2	
Signal	
Screensaver	
Input label	
Wobbling	Off
Component/RGB-in select	RGB
Power management	Off
Auto power off	Off
Standby save	Off(SERIAL)
ECO	Off
OSD Language	English(UK)

↓ Press ACTION (■) button

For Video (S VIDEO)

Signal [AV]	
3D Y/C Filter	On
Colour system	Auto
Cinema reality	Off
Noise reduction	Off

For RGB

Signal [RGB]	
Sync	Auto
Cinema reality	Off
XGA Mode	1024×768
Noise reduction	Off
H-Freq.	63.98 kHz
V-Freq.	60.02 Hz
Signal Format	1280×1024/60

For Component

Signal [Component]	
Cinema reality	Off
XGA Mode	1024×768
Noise reduction	Off
H-Freq.	63.98 kHz
V-Freq.	60.02 Hz
Signal Format	1280×1024/60

For Digital

Signal [Digital]	
Cinema reality	Off
Noise reduction	Off
H-Freq.	63.98 kHz
V-Freq.	60.02 Hz
Dot Clock Freq.	108.0 MHz
Signal Format	1280×1024/60

3D Y/C Filter

Select “Signal” from the “Setup” menu during Video (S Video) input signal. (“Signal [AV]” menu is displayed.)

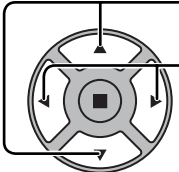
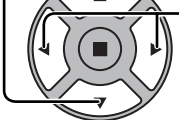
- 1  Press to select the “3D Y/C Filter”
- 2  Press to set On / Off.

3D Y/C Filter	
3D Y/C Filter	On

Colour system

Select Signal from the "Setup" menu during Video (S Video) input signal. ("Signal [AV]" menu is displayed.)

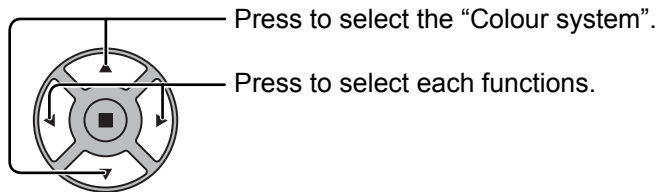

Signal [AV]	
3D Y/C Filter	On
Colour system	Auto
Cinema reality	Off
Noise reduction	Off

If the picture image becomes unstable:

With the system set on Auto, under conditions of low level or noisy input signals the image may in rare cases become unstable. Should this occur, set the system to match the format of the input signal.

Colour system: Set the colour system to match the input signal. When "Auto" is set, Colour system will be automatically selected from NTSC/PAL/SECAM/NTSC 4.43/PAL M/PAL N.

To display PAL60 signal, select "Auto".

→Auto ↔ PAL ↔ SECAM ↔ NTSC ↔ NTSC 4.43 ↔ PAL M ↔ PAL N ←

Cinema reality

Cinema reality:

When on, the display attempts to reproduce a more natural interpretation of sources such as movie pictures, which are recorded at 24 frames per second. If the picture is not stable, turn the setting to off.

Note:

When On, this setting only affects the following signal input:

- NTSC / PAL signal input during Video (S Video) input signal.
- 525i (480i), 625i (575i), 1125 (1080) / 60i signal input during Component input signal.

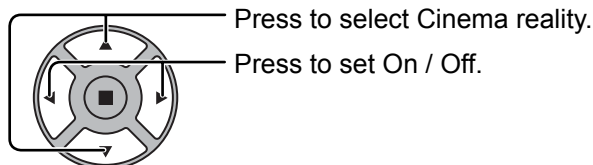

Cinema reality	Off
----------------	-----

XGA Mode

This menu is displayed when the input signal is analog (Component/PC). This menu sets two types of XGA signals with 60Hz vertical frequency having different aspect ratios and sampling rates (1,024 × 768 @ 60Hz and 1,366 × 768 @ 60Hz).

When a 1,280 × 768 @ 60Hz input signal is automatically detected, the image is processed as a 1,280 × 768 @ 60Hz XGA input signal irrespective of this setting.

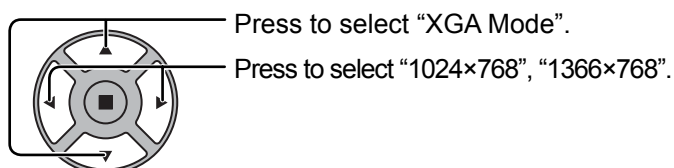

XGA Mode	1024 × 768
----------	------------

Note:

After making this setting, be sure to make each adjustment (such as "Auto Setup") on the "Pos. /Size" menu as necessary. (see page 22)

Noise reduction

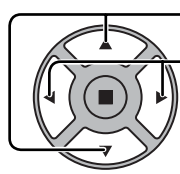

Press to select "Noise reduction".

Press to select "Off", "Auto", "Min", "Mid", "Max".

Auto: Noise reduction will be automatically selected from "Min", "Mid" or "Max".



Note:

Noise reduction can be adjusted while a Video or Component signal is being applied.

Sync

This function operates only during input from PC IN terminal.
Select Signal from the "Setup" menu during Component input signal.

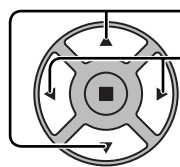

Press to select the "Sync".

Press to adjust.

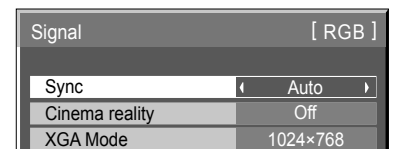

Confirm that the input is set to RGB input (this setting is valid only for RGB input signal).

Auto: The H and V sync or synchronized signal is automatically selected. If both input, it is selected the H and V sync. However, the synchronized signal that is input first is selected.



on G: Uses a synchronized signal on the Video G signal, which is input from the G connector.

Note:

Accepts only RGB signals from COMPONENT/RGB IN terminal with "Sync on G"

Input signal display

Displays the frequency and the type of the current input signal.

This display is valid only for Component / RGB / PC and Digital input signal.

Display range:

Horizontal 30 - 110 kHz

Vertical 48 - 120 Hz

H-Freq.	63.98	kHz
V-Freq.	60.02	Hz
Signal Format	1280×1024/60	

The dot clock frequency is displayed during digital signal input.

H-Freq.	63.98	kHz
V-Freq.	60.02	Hz
Dot Clock Freq.	108.0	MHz
Signal Format	1280×1024/60	

Note:

The automatically detected signal format may be displayed differently than the actual input signal.

Options Adjustments

1  Press to display the Setup menu.

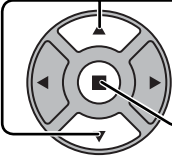
2  Press to select "OSD Language".
Press for more than 3 seconds.

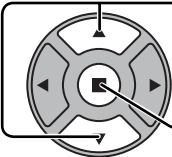
3  Press to select "Options".
Press to display the Options menu.



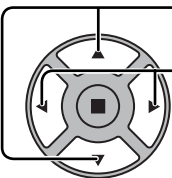

Options		1/2
On screen display	◀ On ▶	
Initial input	◀ Off ▶	
Initial VOL level	◀ Off 0 ▶	
Maximum VOL level	◀ Off 0 ▶	
Input lock	◀ Off ▶	
Button lock	◀ Off ▶	
Remocon User level	◀ Off ▶	

























4  Press to select your preferred menu.
Press to adjust the menu.

Options		2/2
Off-timer function	◀ Enable ▶	
Initial Power Mode	◀ Normal ▶	
Power On Screen Delay	◀ Off ▶	
Clock Display	◀ Off ▶	

5  Press to exit from Options menu.

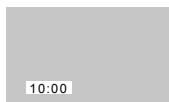

Item	Adjustments
On screen display	<p>On: Displays all the following on screen.</p> <ul style="list-style-type: none"> • Power on display • Input signal switch display • No signal display • Mute and the remaining time of off-timer after  was pressed. <p>Off: Hides all the items above from view.</p>
Initial input	<p>Adjusts the input signal when the unit is turned on. Off ↔ VIDEO ↔ Component/RGB ↔ PC ↔ DVI ↔ HDMI1 ↔ HDMI2 ↔ Off</p> <p>Notes:</p> <ul style="list-style-type: none"> • Only the adjusted signal is displayed. (see page 15) • This menu is available only when "Input lock" is "Off".
Initial VOL level	<p>Press  button to adjust the volume when the unit is turned on.</p> <p>Off ↔ On</p> <p>Off: Sets normal volume. On: Sets your preferred volume.</p> <p>Notes:</p> <ul style="list-style-type: none"> • When "Maximum VOL level" is "On", the volume can only be adjusted between 0 and your maximum range. • You can hear the changed volume regardless of your volume setting before opening the options menu if you adjust the volume when "Initial VOL level" is "On" and cursor is on the menu.
Maximum VOL level	<p>Press  button to adjust the maximum volume.</p> <p>Off ↔ On</p> <p>Off: Sets auto maximum volume. On: Sets your preferred maximum volume.</p> <p>Notes:</p> <ul style="list-style-type: none"> • If the "Maximum VOL level" is set lower than the "Initial VOL level", the "Initial VOL level" automatically becomes the same as the "Maximum VOL level". • The volume display can go up to 100 regardless of the settings. • You can hear the changed volume regardless of your volume setting before opening the options menu if you adjust the volume when "Maximum VOL level" is "On" and cursor is on the menu.
Input lock	<p>Locks the input switch operation. Off ↔ VIDEO ↔ Component/RGB ↔ PC ↔ DVI ↔ HDMI1 ↔ HDMI2 ↔ Off</p> <p>Notes:</p> <ul style="list-style-type: none"> • Only the adjusted signal is displayed (see page 15). • Input switch can be used when this is set to "Off".

Options Adjustments

Item	Adjustments
<p>Button lock</p>	<p>Off \longleftrightarrow On \longleftrightarrow MENU&ENTER Off: All the buttons on main unit can be used. MENU&ENTER: Locks  and  buttons on main unit. On: Locks all the button on main unit. Sets Button lock with the unit buttons in the following procedure. Off: Press  four times \rightarrow Press  four times \rightarrow Press  four times \rightarrow Press  MENU&ENTER: Press  four times \rightarrow Press  four times \rightarrow Press  four times \rightarrow Press  On: Press  four times \rightarrow Press  four times \rightarrow Press  four times \rightarrow Press </p>
<p>Remocon User level</p>	<p>Off \longleftrightarrow User1 \longleftrightarrow User2 \longleftrightarrow User3 Off: You can use all of the buttons on the remote control. User1: You can only use , , , , ,  buttons on the remote control. User2: You can only use  button on the remote control. User3: Locks all the buttons on remote control.</p>
<p>Off-timer function</p>	<p>Enable: Enables the “Off-timer function”. Disable: Disables the “Off-timer function”. Note: When “Disable” is set, the Off-timer is cancelled.</p>
<p>Initial Power Mode</p>	<p>Normal \longleftrightarrow On \longleftrightarrow Standby Sets the power mode of the unit for when the power recovers from failure or after plugging off and in again. Normal: Power returns in as the same state as before the power interruption. Standby: Power returns in standby mode. (Power Indicator : red/orange) On: Power returns in power On. (Power Indicator : green) Note: When using multiple displays, “Standby” is preferred to be set in order to reduce a power load.</p>
<p>Power On Screen Delay</p>	<p>Off \leftrightarrow 1 \leftrightarrow 2 \leftrightarrow 3... \leftrightarrow 30 You can set the power-on delay time of the displays to reduce the power load, when you press / to turn on the multiple displays that are set together, for example, on MULTI DISPLAY system. Set each display’s setting individually. Off: The display will be turned on at the same time as / is pressed. 1 to 30 (sec.): Set the power-on delay time (second). After pressing / , the display will be powered on with time delay depending on this setting. Notes: <ul style="list-style-type: none"> • During this function is working, the power indicator is blinking green. • This function also works when the power recovers from failure or after plugging off and in again the power cord. </p>
<p>Clock Display</p>	<p>Off: Not display the clock. On: Display the clock. The clock is displayed at the lower left of the screen when  button is pressed.  Note: When “PRESENT TIME Setup” is not set, the clock is not displayed even if “Clock Display” is “On”. (see page 27)</p>









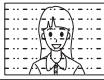

Normalization

When both main unit buttons and remote control are disabled due to the “Button lock” or “Remocon User level” adjustments, set all the values “Off” so that all the buttons are enabled again.

Press the  button on main unit together with  button on the remote control and hold for more than 5 seconds. The “Shipping” menu is displayed and the lock is released when it disappears.

Troubleshooting

Before you call for service, determine the symptoms and make a few simple checks as shown below.

Symptoms		Checks
Picture	Sound	
 Interference	 Noisy Sound	Electrical Appliances Cars / Motorcycles Fluorescent light
 Normal Picture	 No Sound	Volume (Check whether the mute function has been activated on the remote control.)
 No Picture	 No Sound	Not plugged into AC outlet Not switched on Picture and Brightness/Volume setting (Check by pressing the power switch or stand-by button on the remote control.)
 No Picture	 Normal Sound	If a signal with a non-applicable colour system format, or frequency is input, only the input terminal indication is displayed.
 No Colour	 Normal Sound	Colour controls set at minimum level (see page 24, 25) Colour system (see page 38)
No remote control operations can be performed.		Check whether the batteries have discharged completely and, if they have not, whether they were inserted properly. Check whether the remote control sensor is exposed to an outdoor light or a strong fluorescent light. Check whether the remote control designed specifically for use with the unit is being used. (The unit cannot be operated by any other remote control.)
A cracking sound is sometimes heard from the unit.		If there is nothing wrong with the picture or sound, this is the sound of the cabinet undergoing very slight contractions in response to changes in the room temperature. There are no adverse effects on the performance or other aspects.
The top or bottom of the picture on the screen is cut off when I use the zoom function.		Adjust the position of the picture on the screen.
Areas at the top and bottom of the screen where the image is missing appear when I use the zoom function.		When using a video software program (such as a cinema size program) with a screen wider than one in the 16:9 mode, blank areas separate from the images are formed at the top and bottom of the screen.
I can hear sounds coming from inside the unit.		When the power is turned on, a sound of the display panel being driven may be heard: This is normal and not indicative of malfunctioning.
Parts of the unit become hot.		Even when the temperature of parts of the front, top and rear panels has risen, these temperature rises will not pose any problems in terms of performance or quality.
Power automatically turns off unexpectedly.		Check the settings of "Power management" and "Auto power off" in the Setup menu. Any of them may be set to "On". (see page 31)
This LCD Display uses special image processing. Hence a slight time lag may occur between image and audio, depending on the type of input signal. However, this is not a malfunction.		

LCD Display panel

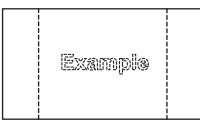
Symptoms	Check
The screen darkens slightly when bright pictures with minimal movements are shown.	The screen will darken slightly when photos, still images of a computer or other pictures with minimal movements are shown for an extended period. This is done to reduce image retention on the screen and the shortening of the screen's service life: It is normal and not indicative of malfunctioning.
It takes a while for the picture to appear.	The unit digitally processes the various signals in order to reproduce esthetically pleasing images. As such, it sometimes takes a few moments for the picture to appear when the power has been turned on, when the input has been switched.
The edges of the images flicker.	Due to the characteristics of the system used to drive the panel, the edges may appear to flicker in the fast-moving parts of the images: This is normal and not indicative of malfunctioning.
There may be red spots, blue spots, green spots and black spots on the screen.	This is a characteristic of liquid crystal panels and is not a problem. The liquid crystal panel is built with very high precision technology giving you fine picture details. Occasionally, a few non-active pixels may appear on the screen as fixed points of red, blue, green, or black. Please note this does not affect the performance of your LCD.
 Image retention appears	Image retention may occur. If you display a still picture for an extended period, the image might remain on the screen. However, it will disappear after a while. This is not considered as malfunction.

Applicable Input Signals

PC signals

*Mark: Applicable input signal

	Signal name	Horizontal frequency (kHz)	Vertical frequency (Hz)	RGB IN (Dot clock (MHz))	PC IN (Dot clock (MHz))	DVI-D IN (Dot clock (MHz))	HDMI1 HDMI2
1	640x400@70Hz	31.46	70.07	*(25.17)	*(25.17)	*(25.17)	
2	640x400@85Hz	37.86	85.08	*(31.5)	*(31.5)	*(31.5)	
3	640x480@60Hz	31.43	59.88	*(25.15)	*(25.15)	*(25.15)	
4	640x480@60Hz	31.47	59.94	*(25.18)	*(25.18)	*(25.18)	*
5	640x480@67Hz	35.00	66.67	*(30.24)	*(30.24)	*(30.24)	
6	640x480@72Hz	37.86	72.81	*(31.5)	*(31.5)	*(31.5)	
7	640x480@75Hz	37.50	75.00	*(31.5)	*(31.5)	*(31.5)	
8	640x480@85Hz	43.27	85.01	*(36.0)	*(36.0)	*(36.0)	
9	720x400@70Hz	31.47	70.08	*(28.32)	*(28.32)	*(28.32)	
10	800x600@55Hz	34.50	55.38	*(35.33)	*(35.33)	*(35.33)	
11	800x600@56Hz	35.16	56.25	*(36.0)	*(36.0)	*(36.0)	
12	800x600@60Hz	37.88	60.32	*(40.0)	*(40.0)	*(40.0)	*
13	800x600@60Hz	38.00	60.51	*(40.13)	*(40.13)	*(40.13)	
14	800x600@72Hz	48.08	72.19	*(50.0)	*(50.0)	*(50.0)	
15	800x600@75Hz	46.88	75.00	*(49.5)	*(49.5)	*(49.5)	
16	800x600@85Hz	53.67	85.06	*(56.25)	*(56.25)	*(56.25)	
17	852x480@60Hz	31.47	59.94	*(33.54)	*(33.54)	*(34.24)	
18	1,024x768@50Hz	39.55	50.00	*(51.89)	*(51.89)	*(51.89)	
19	1,024x768@60Hz	48.36	60.00	*(65.0)	*(65.0)	*(65.0)	*
20	1,024x768@60Hz	48.50	60.02	*(64.99)	*(64.99)	*(65.18)	
21	1,024x768@70Hz	56.48	70.07	*(75.0)	*(75.0)	*(75.0)	
22	1,024x768@75Hz	60.24	74.93	*(80.0)	*(80.0)	*(80.0)	
23	1,024x768@75Hz	60.02	75.03	*(78.75)	*(78.75)	*(78.75)	
24	1,024x768@75Hz	61.01	75.70	*(80.05)	*(80.05)	*(81.0)	
25	1,024x768@85Hz	68.68	85.00	*(94.5)	*(94.5)	*(94.5)	
26	1,024x768@120Hz	97.55	119.99		*(115.5)	*(115.5)	
27	1,066x600@60Hz	37.64	59.94	*(53.0)	*(53.0)	*(53.0)	
28	1,152x864@60Hz	53.70	60.00	*(81.62)	*(81.62)	*(81.62)	
29	1,152x864@75Hz	67.50	75.00	*(108.0)	*(108.0)	*(108.0)	
30	1,152x900@65Hz	61.20	65.20	*(92.0)	*(92.0)	*(92.0)	
31	1,152x900@66Hz	61.85	66.00	*(94.5)	*(94.5)	*(94.5)	
32	1,152x900@75Hz	71.40	75.60	*(105.1)	*(105.1)	*(105.1)	
33	1,280x768@60Hz	47.78	59.87	*(79.50)	*(79.50)	*(79.50)	
34	1,280x800@50Hz	41.20	50.00	*(68.55)	*(68.55)	*(68.55)	
35	1,280x960@60Hz	60.00	60.00	*(108.0)	*(108.0)	*(108.0)	
36	1,280x960@85Hz	85.94	85.00	*(148.5)	*(148.5)	*(148.5)	
37	1,280x1,024@50Hz	52.70	50.00	*(89.38)	*(89.38)	*(89.38)	
38	1,280x1,024@60Hz	63.34	59.98	*(108.18)	*(108.18)	*(108.18)	
39	1,280x1,024@60Hz	63.90	60.00	*(107.35)	*(107.35)	*(107.35)	
40	1,280x1,024@60Hz	63.37	60.01	*(107.5)	*(107.5)	*(107.5)	
41	1,280x1,024@60Hz	63.74	60.02	*(108.1)	*(108.1)	*(108.1)	
42	1,280x1,024@60Hz	63.98	60.02	*(108.0)	*(108.0)	*(108.0)	*
43	1,280x1,024@60Hz	63.79	60.18	*(108.19)	*(108.19)	*(108.19)	
44	1,280x1,024@66Hz	70.66	66.47	*(119.84)	*(119.84)	*(119.84)	
45	1,280x1,024@75Hz	79.98	75.02	*(135.0)	*(135.0)	*(135.0)	
46	1,280x1,024@76Hz	81.13	76.11	*(135.0)	*(135.0)	*(135.0)	
47	1,280x1,024@85Hz	91.15	85.02		*(157.5)	*(157.5)	
48	1,360x768@60Hz	47.71	60.02	*(85.5)	*(85.5)	*(85.5)	
49	1,366x768@50Hz	39.55	50.00	*(69.92)	*(69.92)	*(69.92)	
50	1,366x768@60Hz	48.36	60.00	*(86.71)	*(86.71)	*(87.44)	
51	1,400x1,050@60Hz	65.12	59.91	*(121.38)	*(121.38)	*(122.43)	
52	1,400x1,050@60Hz	65.32	59.98	*(121.75)	*(121.75)	*(121.75)	
53	1,400x1,050@60Hz	65.35	60.12	*(121.81)	*(121.81)	*(121.85)	
54	1,400x1,050@75Hz	82.28	74.87	*(156.0)	*(156.0)	*(156.0)	
55	1,600x1,200@60Hz	75.00	60.00	*(162.0)	*(162.0)	*(162.0)	
56	1,920x1,080@60Hz	67.50	60.00	*(148.5)	*(148.5)	*(148.5)	
57	1,920x1,200@60Hz	74.04	59.95		*(154.0)	*(154.0)	
58	Macintosh13" (640x480)	35.00	66.67	*(30.24)	*(30.24)	*(30.24)	
59	MacintoshLC13" (640x480)	34.97	66.60	*(31.33)	*(31.33)	*(31.33)	
60	Macintosh16" (832x624)	49.72	74.55	*(57.28)	*(57.28)	*(57.28)	
61	Macintosh19" (1,024x768)	60.24	75.08	*(80.0)	*(80.0)	*(80.0)	
62	Macintosh21" (1,152x870)	68.68	75.06	*(100.0)	*(100.0)	*(100.0)	
63	Macintosh II (1,280x1,024)	80.00	75.00	*(134.4)	*(134.4)	*(135.2)	

Component signals

*Mark: Applicable input signal

	Signal name	Horizontal frequency (kHz)	Vertical frequency (Hz)	COMPONENT IN (Dot clock (MHz))	DVI-D IN (Dot clock (MHz))	HDMI1 HDMI2
1	525(480)/60i	15.73	59.94	* (13.5)	* (27.0)	*
2	525(480)/60p	31.47	59.94	* (27.0)	* (27.0)	*
3	625(575)/50i	15.63	50.00	* (13.5)		
4	625(576)/50i	15.63	50.00		* (27.0)	*
5	625(575)/50p	31.25	50.00	* (27.0)		*
6	625(576)/50p	31.25	50.00		* (27.0)	*
7	750(720)/60p	45.00	60.00	* (74.25)	* (74.25)	*
8	750(720)/50p	37.50	50.00	* (74.25)	* (74.25)	*
9	1,125(1,080)/60p	67.50	60.00	* (148.5)*1	* (148.5)	*
10	1,125(1,080)/60i	33.75	60.00	* (74.25)*1	* (74.25)	*
11	1,125(1,080)/50p	56.25	50.00	* (148.5)*1	* (148.5)	*
12	1,125(1,080)/50i	28.13	50.00	* (74.25)*1	* (74.25)	*
13	1,125(1,080)/24sF	27.00	48.00	* (74.25)*2		
14	1,125(1,080)/30p	33.75	30.00	* (74.25)*1	* (74.25)	*
15	1,125(1,080)/25p	28.13	25.00	* (74.25)*1	* (74.25)	*
16	1,125(1,080)/24p	27.00	24.00	* (74.25)*1	* (74.25)	*



*1: Based on SMPTE 274M standard. *2: Based on SMPTE RP211 standard.

Video signals (VIDEO, S-VIDEO)

	Signal name	Horizontal frequency(kHz)	Vertical frequency(Hz)
1	NTSC	15.73	59.94
2	PAL	15.63	50.00
3	PAL60	15.73	59.94
4	SECAM	15.63	50.00
5	NTSC 4.43	15.73	59.94
6	PAL N	15.63	50.00
7	PAL M	15.73	59.94

Shipping condition

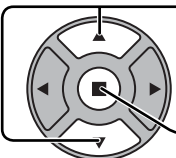
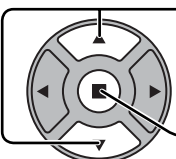
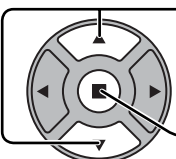
This function allows you to reset the unit to the factory setting.

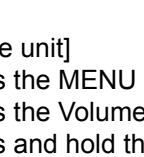
-  Press to display the Setup menu.
-  Press to select "OSD Language".
 Press for more than 3 seconds.
-  Press to select "Shipping".
 Press to display the Shipping menu.
-  Press to select "YES".
 Press to confirm.

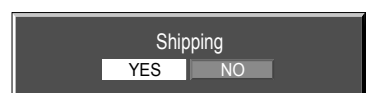
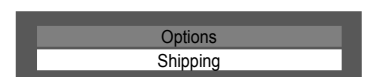
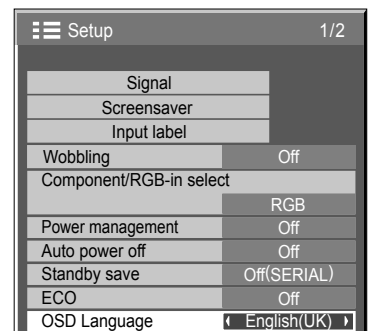

[from the unit]

- Press the MENU button till the Setup menu is displayed.
- Press the Volume Up "+" or Down "-" button to select "OSD Language".
- Press and hold the ENTER button till the Shipping menu is displayed.
- Press the Volume Up "+" or Down "-" button to select "YES".
- Press the ENTER button and wait for 10 sec.

Specifications

	TH-42LF20E	TH-47LF20E
Power Source	220 - 240 V AC, 50/60Hz	
Power Consumption		
Power on	240 W	290 W
Stand-by condition	0.2 W	0.2 W
Power off condition	0.2 W	0.2 W
LCD Display panel	42-inch IPS panel, 16:9 aspect ratio	47-inch IPS panel, 16:9 aspect ratio
Screen size	930 mm (W) × 523 mm (H) × 1,067 mm (diagonal)	1,040 mm (W) × 585 mm (H) × 1,193 mm (diagonal)
(No. of pixels)	2,073,600 (1,920 (W) × 1,080 (H)) [5,760 × 1,080 dots]	2,073,600 (1,920 (W) × 1,080 (H)) [5,760 × 1,080 dots]
Operating condition		
Temperature	0 °C - 40 °C	
Humidity	20 % - 80 %	
Applicable signals		
Colour System	NTSC, PAL, PAL60, SECAM, NTSC 4.43, PAL M, PAL N	
Scanning format	525 (480) / 60i · 60p, 625 (575) / 50i · 50p, 750 (720) / 60p · 50p, 1125 (1080) / 60i · 60p · 50i · 50p · 24p · 25p · 30p · 24sF, 1250 (1080) / 50i	
PC signals	VGA, SVGA, XGA, SXGA UXGA (compressed) Horizontal scanning frequency 30 - 110 kHz Vertical scanning frequency 48 - 120 Hz	
Connection terminals		
AV IN	VIDEO S-VIDEO AUDIO L-R	BNC Mini DIN 4PIN RCA Pin jack × 2 1.0 Vp-p (75 Ω) Y: 1.0 Vp-p (75 Ω), C: 0.286 Vp-p (75 Ω) 0.5 Vrms
HDMI 1/2		TYPE A Connector
COMPONENT/RGB IN	G/Y B/Pb/Cb R/Pr/CR AUDIO L-R	BNC BNC BNC RCA Pin jack × 2 with sync 1.0 Vp-p (75 Ω) 0.7 Vp-p (75 Ω) 0.7 Vp-p (75 Ω) 0.5 Vrms
DVI-D IN	AUDIO	DVI-D 24 Pin Content Protection Stereo mini jack (M3) × 1 Compliance with DVI Revision 1.0 Compatible with HDCP 1.1 0.5 Vrms, Shared with PC IN
PC IN	AUDIO	High-Density Mini D-sub 15 Pin VBS (use HD port) Stereo mini jack (M3) × 1 G with sync 1.0 Vp-p (75 Ω) G without sync 0.7 Vp-p (75 Ω) B: 0.7 Vp-p (75 Ω) R: 0.7 Vp-p (75 Ω) HD/VD: 1.0 - 5.0 Vp-p (high impedance) with picture 1.0 Vp-p (high impedance) without picture 0.3 Vp-p (high impedance) 0.5 Vrms, Shared with DVI-D IN
SERIAL		External Control Terminal D-sub 9 Pin RS-232C compatible
Sound		
Speakers	50 mm × 90 mm × 2 pcs	
Audio Output	10 W [5 W + 5 W] (10 % THD)	
Dimensions (W × H × D)	968 mm × 561 mm × 101 mm	1,079 mm × 624 mm × 101 mm
Mass (weight)	approx. 18.0 kg	approx. 23.0 kg

Notes:

- Design and specifications are subject to change without notice. Mass and dimensions shown are approximate.
- This equipment complies with the EMC standards listed below.
EN55022, EN55024, EN61000-3-2, EN61000-3-3.

Information for Users on Collection and Disposal of Old Equipment and used Batteries

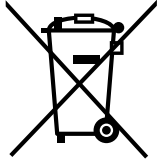

These symbols on the products, packaging, and/or accompanying documents mean that used electrical and electronic products and batteries should not be mixed with general household waste. For proper treatment, recovery and recycling of old products and used batteries, please take them to applicable collection points, in accordance with your national legislation and the Directives 2002/96/EC and 2006/66/EC.

By disposing of these products and batteries correctly, you will help to save valuable resources and prevent any potential negative effects on human health and the environment which could otherwise arise from inappropriate waste handling.

For more information about collection and recycling of old products and batteries, please contact your local municipality, your waste disposal service or the point of sale where you purchased the items. Penalties may be applicable for incorrect disposal of this waste, in accordance with national legislation.

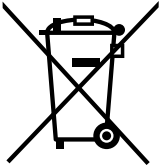

For business users in the European Union

If you wish to discard electrical and electronic equipment, please contact your dealer or supplier for further information.

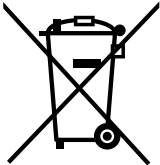

[Information on Disposal in other Countries outside the European Union]

These symbols are only valid in the European Union. If you wish to discard these items, please contact your local authorities or dealer and ask for the correct method of disposal.

Note for the battery symbol (bottom two symbol examples):

This symbol might be used in combination with a chemical symbol. In this case it complies with the requirement set by the Directive for the chemical involved.

Cd

Customer's Record

The model number and serial number of this product can be found on its rear panel. You should note this serial number in the space provided below and retain this book, plus your purchase receipt, as a permanent record of your purchase to aid in identification in the event of theft or loss, and for Warranty Service purposes.

Model Number _____

Serial Number _____

Pursuant to the directive 2004/108/EC, article 9(2)

Panasonic Testing Centre

Panasonic Service Europe, a division of Panasonic Marketing Europe GmbH

Winsbergring 15, 22525 Hamburg, F.R. Germany

Panasonic Corporation

Web Site : <http://panasonic.net>

© Panasonic Corporation 2010